



# TOSHIBA

## OWNER'S MANUAL

---

32V35MU/32V35MC

43V35MU/43V35MC

### **Owner's Record**

You will find the model number and serial number on the back of the TV. Record these numbers in the spaces provided below. Refer to them whenever you call upon your Toshiba TV dealer regarding this product.

# Find what you want

This TV is equipped with a owner's manual and embedded E-Manual.  
Before using the TV, please read the following documentation.

### OWNER'S MANUAL

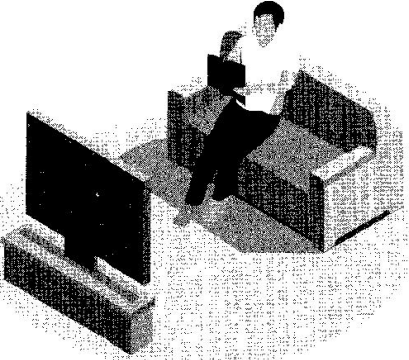

**Please read the owner's manual to learn about the following content:**

- What's in the box
- Getting started
- Product Specifications





### E-Manual

**To get more information, please check the E-Manual.**

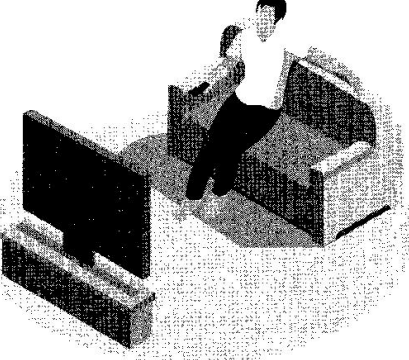
Find the E-Manual in  >  **Settings**  
> **Support** > **E-Manual**.



### E-Manual support functions

	<b>Search</b>	Find the help you are looking for.
	<b>Try Now</b>	Go directly to the function page and try it.
	<b>QR Code</b>	Scan to open the E-Manual on your mobile device.

# Copyright statement

© 2023 Hisense Group All Rights Reserved.

Copyright protected material in this owner's manual may be owned by Hisense group, its contractors or other third parties. Unless otherwise stated, the exercise of any of the exclusive rights under the copyright laws in relation to the material on this site is not permitted without the consent of the rights owner or as otherwise covered by a statutory license.

No part of this publication may be stored, reproduced, transmitted or distributed, in whole or in part, in any manner, electronic or otherwise, whether or not for a charge or for other or no consideration, without the prior written permission of Hisense group. Requests for permission to store, reproduce, transmit or distribute materials may be made to the following address:

## USA:

Hisense USA Corporation  
105 Satellite BLVD Suite I, Suwanee, GA 30024

## CANADA:

Hisense Canada Co., Ltd  
2283 Argentia Road, Unit 16  
Mississauga, ON, Canada  
L5N 5Z2

Hisense hereby declares that we are the licensed entities of using, promoting, advertising "Toshiba" trademark in relation to licensed products via permitted method. In no event shall anyone be allowed to use, transfer, reproduce, distribute, or transmit in any manner any materials under "Toshiba" without written consent by us.

# Disclaimer

Disclaimer: Subscriptions or other payments may be required to access content through some applications. Some or all of the included or downloaded application services in this Toshiba device may not function depending on the Internet connection, local limitations of included applications or other reasons outside of Hisense group's control. Hisense group EXPRESSLY DISCLAIMS RESPONSIBILITY FOR ANY APPLICATION SERVICE FROM FUNCTIONING AT ANY TIME, FOR CONTENT IN ANY APPLICATION SERVICE, FOR DISRUPTIONS OF SERVICE, LOCAL OR REGIONAL LIMITATIONS, WARRANTIES OF TITLE, NO INFRINGEMENT, AND FOR IMPLIED WARRANTIES OF MERCHANTABILITY OR FITNESS FOR A PARTICULAR PURPOSE. By purchasing this device, you accept such Disclaimer without any claim on Hisense group at any time.

# Table of Contents

<b>What's in the box</b> .....	<b>3</b>
<b>Getting started</b> .....	<b>4</b>
Step 1. Attach stand or mount or P-Clip .....	4
Step 2. Connect devices to your TV .....	7
Step 3. Get your remote ready.....	8
Step 4. Power on the TV .....	10
Step 5. Complete the first-time setup.....	10
Step 6. Establish a network connection .....	10
Step 7. Enjoy your TV! .....	10
<b>Troubleshooting</b> .....	<b>11</b>
<b>Product Specifications</b> .....	<b>12</b>
<b>Certification and Compliance</b> .....	<b>13</b>

Congratulations on the purchase of your Toshiba TV! If you would like to know 'all things Toshiba', contact us using the support info:  
 The model and serial number of the TV is located on the back and/or on one side of the TV.  
 We recommend that you record this if you ever need service.

Country	Customer Care Center	Support Page	Register your TV
U.S.A	<ul style="list-style-type: none"> <li>• <b>Phone:</b> 1-888-407-0396</li> <li>• <b>Hours of Operation:</b>                Monday - Friday: 9 AM to 9 PM EST                Saturday - Sunday: 9 AM to 6 PM EST</li> <li>• <b>Service Email:</b>                USAservice@toshiba-visual.com</li> </ul>	<p><a href="https://www.toshibatv-usa.com/support">https://www.toshibatv-usa.com/support</a></p> 	<p><a href="https://www.toshibatv-usa.com/support/register/">https://www.toshibatv-usa.com/support/register/</a></p> 
CANADA	<ul style="list-style-type: none"> <li>• <b>Phone:</b> 1-855-822-2929</li> <li>• <b>Hours of Operation:</b>                Monday - Friday: 8 AM to 8 PM EST</li> <li>• <b>Service Email:</b>                canadasupport@toshibatv-canada.com</li> </ul>	<p><a href="http://www.toshibatv-canada.com/support/">http://www.toshibatv-canada.com/support/</a></p> 	<p><a href="http://www.toshibatv-canada.com/support/register/">http://www.toshibatv-canada.com/support/register/</a></p> 

**Disclaimer:** This owner's manual is intended as a general guideline to help you set up your TV. Images throughout this document are for illustrative purposes only and may differ from the actual product.

# What's in the box

Your Toshiba TV comes with the following items:

- TV
- remote control
- 2 base stands
- 4 screws
- owner's manual (this document)
- 1 set of AA batteries
- Important Safety Information and Warranty Card
- Optional, some countries/regions may not have:  
P-Clip × 1 (with 1 screw M6×12 and 1 screw ST4×25C)

## NOTE:

- The accessories may be different from the list above due to different models, countries/regions, please refer to the actual accessory bag.

## IMPORTANT:

To prevent accidentally discarding items that came with your TV, be sure to **check ALL of the foam** in the carton box.



You will also need the following items (which are not included) to set up your TV:

- Wireless router (not included) for Internet connectivity
- Phillips screwdriver (not included) to secure the TV stand
- Not all connection cables are included. Some cables are sold separately to connect external devices to the TV.
- Wall mount bracket and screws (not included) if you prefer to mount the TV on the wall

# Getting started

## Step 1. Attach stand or mount or P-Clip

Before you start using your TV, attach your TV stand or mount it on the wall.

### CAUTION:

- Disconnect the AC power cord before installing a stand or a wall mount bracket.
- The display on your TV is fragile. Make sure the TV screen is not scratched or damaged by hard objects or from pressure.
- After the installation is complete, make sure the TV is steady on a table or firmly attached to a wall mount, before removing all protective film, if any.

## Attach the TV stand

To attach the TV stand legs to your TV:

1. Carefully place your TV face down on a clean, soft, flat surface.
2. Insert the base stands into the bottom slots on your TV.
3. Use the screws provided to secure each stand tightly.

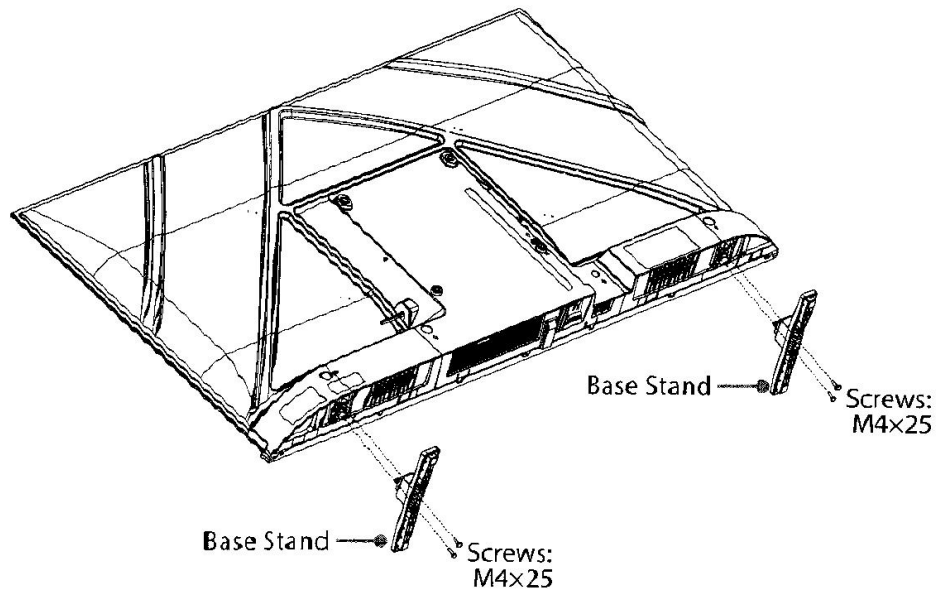

## Attach the wall mount bracket (not included)

Before you begin the third-party manufacturer instructions, be sure to do the following things:

1. Place the TV face down on a clean, safe and cushioned surface.
2. Remove the TV stand if you have already attached it.
3. Place spacers (not included) in the corresponding bracket holes.

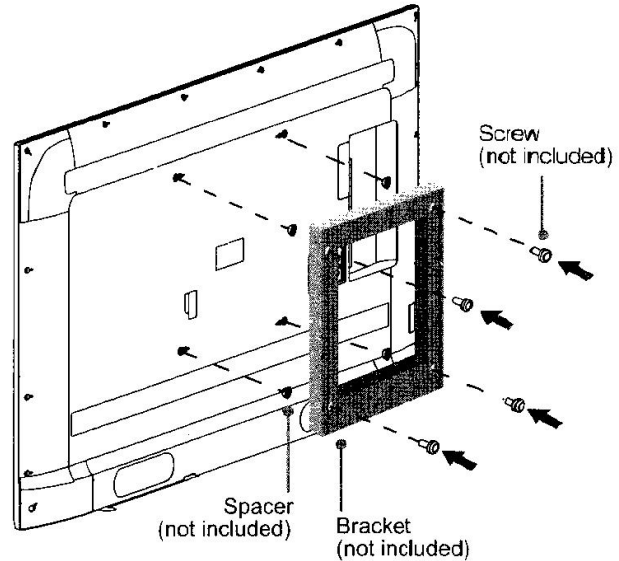

### CAUTION:

- Follow instructions provided with the wall mount bracket. If it is not correctly mounted, the TV may fall and cause property damage or personal injury.
- When you attach the mount, be sure to use spacers (provided by the third-party manufacturer) between the TV and the bracket.
- To prevent internal damage to the TV and to ensure it is mounted securely, be sure to use fixing screws (not included) that are 8.0 - 10.0 mm in length when measured from the attaching surface of the rear cover.

8.0 - 10.0 mm

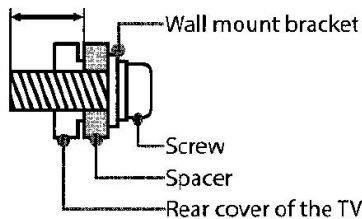

Wall mount hole pattern(mm)

100 × 200 (32")

200 × 200 (43")

Wall mount screw size

M6

- We do not recommend hanging the TV on a slanted wall, and when wall mounting make sure your television remains parallel to the wall and does not lean forward.

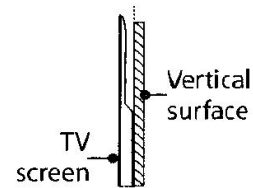

### NOTE:

- If you have additional questions, please contact the wall mount manufacturer or the retailer from which you purchased the TV.
- The diameter and length of the screws differ depending on the wall mount bracket model.



## Attach the P-Clip

Please place the TV on a **horizontally stable surface**, and then use P-Clip to connect the TV and the wall or pillar. (Marked in the illustration below.)

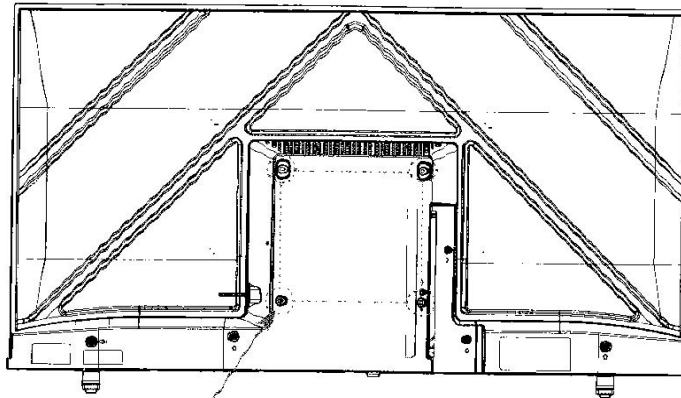

screw hole

Select a suitable screw hole based on the actual situation

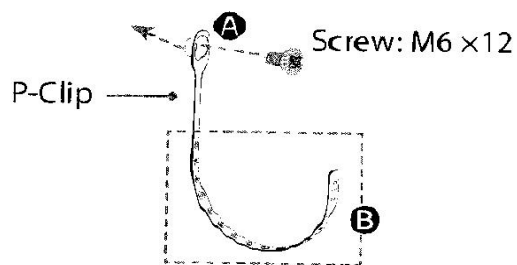

1. Fix **A** part of P-Clip to the screw hole on the back of TV set with a M6x12 screw.
2. Select a suitable hole of P-Clip on **B** part and fix it to the wall or pillar with a ST4x25C screw.

### NOTE:

- Insecure installation may cause the tilt or falling of the product, and further lead to personal injuries or product damages. If the method above can not fix the product, please consult the manufacturers.
- P-Clip is optional, your device may not have P-Clip, please refer to the actual accessories.





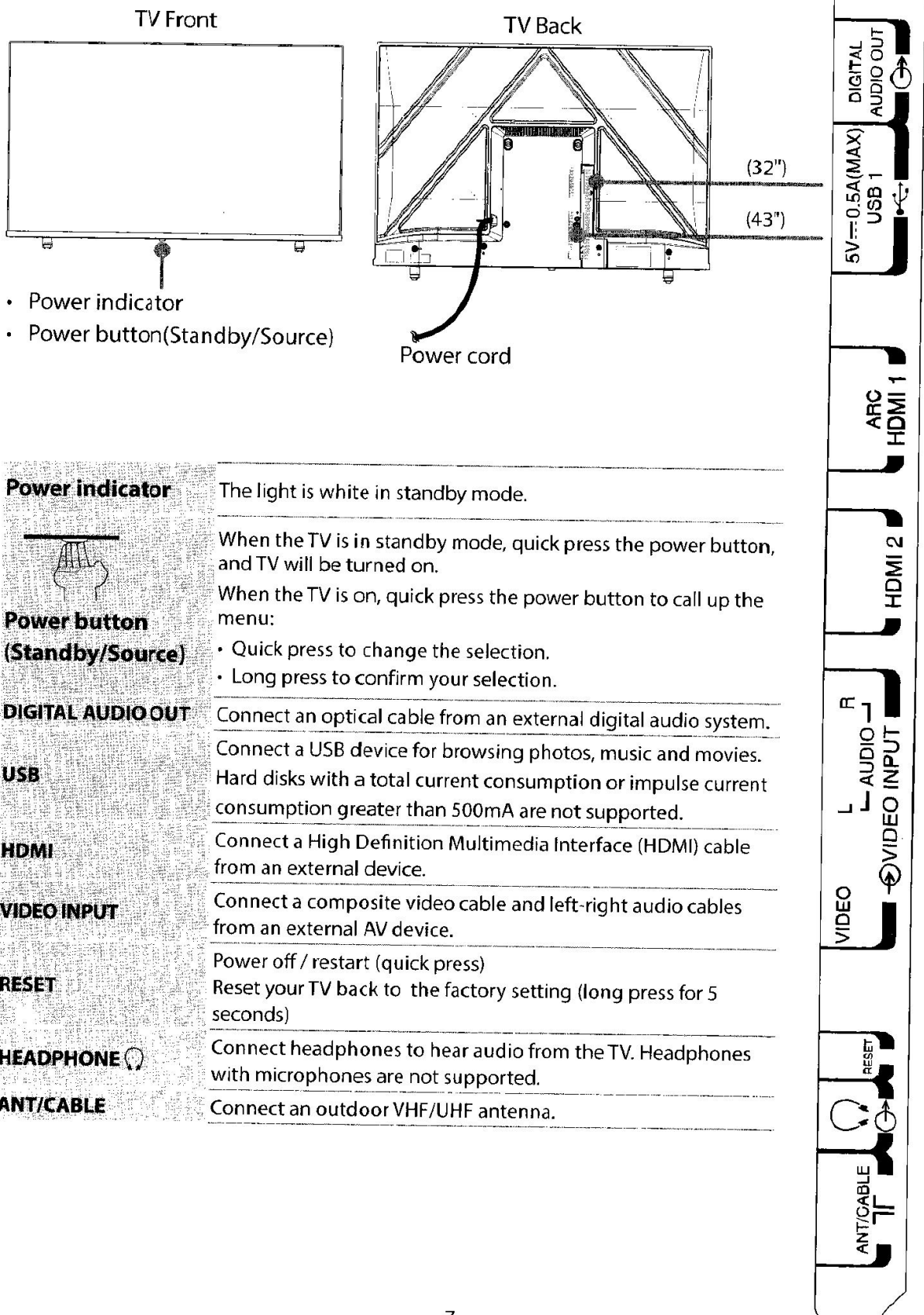







## Step 2. Connect devices to your TV

Check to ensure that you have connected right cables for right ports securely. Loose connections can affect the quality of the picture image and color.



### Step 3. Get your remote ready

The following table shows the buttons on your remote control and describes what they are for.

<b>BUTTON</b>	<b>DESCRIPTION</b>
	Power on/off
INPUT	Change TV Input source
APP	Quick access buttons to apps
	Custom to launch input or app
	Media content control function buttons
	The button for the Menu
	Special function buttons
	D-pad (up/down/left/right navigation buttons)
OK	Confirmation button
	Return to the previous place in the menu or app
EXIT	Exit the menu or exit the application
	Volume (up/down)
	Channel (up/down)
	Display the Home screen
	Mute and restore sound
LIVE TV	Select Live TV channel
SLEEP	Adjust sleep timer setting
MTS	Set the audio language (MTS)
Number	Enter Channels/input numbers
	Select a digital sub-channel
CC	Turn Closed Caption On/Off and turn Closed Caption on when mute

#### NOTE:

- Buttons listed here are for reference only. Actual remote control models may vary.

## **Insert the batteries**

1. Take off the back cover to open the battery compartment of the remote control.
2. Insert two AA(1.5Vcc) size batteries. Make sure to match the (+) and (-) ends of the batteries with the (+) and (-) ends indicated in the battery compartment.
3. Restore the battery compartment cover.

## **Important Information about the remote and batteries**

- **Discard batteries in a designated disposal area. Do not throw them into a fire.**
- **Remove old batteries immediately to prevent them from leaking into the battery compartment.**
- **If you do not intend to use the remote control for a long time, then remove the batteries.**
- **Battery chemicals can cause a rash. If the batteries leak, clean the battery compartment with a cloth. If chemicals touch your skin then wash it immediately.**
- **Do not mix old and new batteries.**
- **Do not mix alkaline, standard (carbon-zinc) or rechargeable (NiCd, NiMH, etc.) batteries.**
- **Do not continue using the remote if it gets warm or hot.**
- **Call our Support Center immediately on the support website.**

## **Remote Control Range Information**

- The remote control can work at a distance of up to 26 feet (792.5 cm) in front of the TV set.
- It can work at a 30 degree horizontal or vertical angle.

## **Using Your Cable Set-top Box or Satellite Receiver Remote as a 'Universal' Remote**

If you prefer to use your Cable Set-top Box or Satellite Receiver Remote as a 'Universal' Remote, then visit the Support page to view a list of the codes.

## Step 4. Power on the TV

Plug your power cord to a power outlet.

Your TV will display a launch screen showing the Toshiba logo.

## Step 5. Complete the first-time setup

The first time you turn on your TV, there is a guided setup to make it easy to connect your TV to the Internet and complete the setup of your TV.

## Step 6. Establish a network connection

1. Press the **Home** button on the remote control, and select the  icon to enter the Settings menu.
2. Select **Network > Network Configuration**.

### Establish a wireless network connection

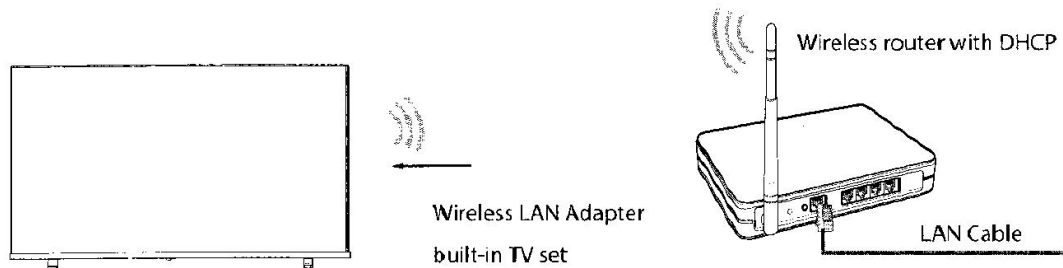

The TV can directly receive network signals via wireless router.

1. Turn on your Wireless router.
2. Choose **Wireless** among **Connection Type**, and the list of networks will display on screen automatically.
3. Select a wireless network from the list, and enter password.
4. If you couldn't find your network, select **Refresh** to get the latest list. Alternatively, you can select **Add** to input a wireless name, select the type of security mode, and enter password.

### Close the network connection

Turn off your Wireless router. The network connection will close.

## Step 7. Enjoy your TV!

Now that you've completed the first-time setup. Your TV provides a variety of entertainment options, so you'll always find something new. Use your TV to watch live channels, access video on demand to watch movies, and much more.

# Troubleshooting

If you are having trouble with your TV, first try turning it off and on again. If this does not fix the problem, check the tips in the following table. If your problem is not listed in the following table, then contact us at one of the phone numbers on before.

Issues	Possible solutions
No sound or picture	<ul style="list-style-type: none"> <li>• Check if the power cord is plugged into a powered AC outlet.</li> <li>• Press the Power button on the remote control to activate the unit from 'Standby' mode.</li> <li>• Check to see if the LED light is on or not. If it is, then the TV is receiving power.</li> </ul>
I have connected an external source to my TV and I get no picture and/or sound.	<ul style="list-style-type: none"> <li>• Check for the correct output connection on the external source and for the correct input connection on the TV.</li> <li>• Make sure you have made the correct selection for the input mode for the incoming signal.</li> </ul>
When I turn on my TV, there is a delay for a few seconds before the picture appears. Is this normal?	<ul style="list-style-type: none"> <li>• Yes, this is normal. The TV is initializing and searching for previous setting information.</li> </ul>
The picture is normal but there is no sound	<ul style="list-style-type: none"> <li>• Check the volume settings.</li> <li>• Check if 'Mute' mode is set to On.</li> </ul>
Sound but no picture or black and white picture	<ul style="list-style-type: none"> <li>• If the picture is black and white, unplug the TV from the AC outlet and replug it after 60 seconds.</li> <li>• Check that the Color is set to 50 or higher.</li> <li>• Try different TV channels.</li> </ul>
The sound and/or picture is distorted or appears wavy	<ul style="list-style-type: none"> <li>• An electric appliance may be affecting the TV. Turn off any appliances that are nearby and move it farther away from the TV.</li> <li>• Insert the power plug of the TV set into another power outlet.</li> </ul>
The sound and picture is blurry or cuts out	<ul style="list-style-type: none"> <li>• If using an external antenna, check the direction, position and connection of the antenna.</li> <li>• Adjust the direction of your antenna or reset or fine tune the channel.</li> </ul>
A horizontal or vertical stripe appears on the picture and/or the picture is shaking	<ul style="list-style-type: none"> <li>• Check if there is an appliance or electric tool nearby that is causing interference.</li> </ul>
The plastic cabinet makes a "clicking" type of sound	<ul style="list-style-type: none"> <li>• The 'click' sound can occur when the temperature of the television changes. This change causes the television cabinet to expand or contract, which makes the sound. This is normal and the TV is OK.</li> </ul>
The remote control does not work	<ul style="list-style-type: none"> <li>• Confirm that TV still has power and is operational.</li> <li>• Change the batteries in the remote control.</li> <li>• Check if the batteries are correctly installed.</li> </ul>

# Product Specifications

Model Name		32V35MU / 32V35MC	43V35MU / 43V35MC
Dimension (W × H × D)	Without Stand	28.6 × 16.9 × 3.3 inches (726 × 430 × 83 mm)	38.0 × 22.2 × 3.5 inches (965 × 563 × 88 mm)
	With Stand	28.6 × 18.1 × 7.3 inches (726 × 459 × 186 mm)	38.0 × 23.3 × 7.3 inches (965 × 592 × 186 mm)
Weight	Without Stand	8.2 lbs (3.7 kg)	13.4 lbs (6.1 kg)
	With Stand	8.4 lbs (3.8 kg)	13.7 lbs (6.2 kg)
TV Stand Width (W × D)		24.6 × 7.3 inches (624 × 186 mm)	29.7 × 7.3 inches (754 × 186 mm)
Active Screen Size (Diagonal)		31.5 inches	42.5 inches
Screen Resolution		1366 × 768	1920 × 1080
Audio Power		6W + 6W	7W + 7W
Power consumption		Please refer to the rating label.	
Power Supply		Please refer to the rating label.	
Connectivity		Built-in Wireless feature (2x2 dual band)	
Receiving Channels		VHF: 2 - 13, UHF: 14 - 69, CATV: 1 - 125 Digital Terrestrial Broadcast (8VSB): 2 - 69 Digital cable (64/256 QAM): 1 - 135	
Tuner Type		Frequency synthesized	
Receiving System		Analog: NTSC Digital: ATSC/QAM	
Operating Temperature		41°F - 95°F (5°C - 35°C)	
Operating Humidity		20% to 80% non-condensing	
Storage Temperature		5°F to 113°F (-15°C to 45°C)	
Storage Humidity		10% to 70%, non-condensing	

*Disclaimer: All products, product specifications, and data are subject to change without notice to improve reliability, function, design or otherwise.*

# Certification and Compliance

**NOTE:** The following warnings only apply to products with such certification.

This device complies with Part 15 of the FCC Rules. Operation is subject to the following two conditions: (1) This device may not cause harmful interference, and (2) This device must accept any interference received, including interference that may cause undesired operation.

**Note:** This equipment has been tested and found to comply with the limits for a Class B digital device, pursuant to Part 15 of the FCC Rules. These limits are designed to provide reasonable protection against harmful interference in a residential installation. This equipment generates, uses, and can radiate radio frequency energy and, if not installed and used in accordance with the instructions, may cause harmful interference to radio communications. However, there is no guarantee that interference will not occur in a particular installation. If this equipment does cause harmful interference to radio or television reception, which can be determined by turning the equipment off and on, the user is encouraged to try to correct the interference by one or more of the following measures:

- Reorient or relocate the receiving antenna.
- Increase the separation between the equipment and receiver.
- Connect the equipment into an outlet on a circuit different from that to which the receiver is connected.
- Consult the dealer or an experienced radio/TV technician for help.

The manufacturer is not responsible for any radio or TV interference caused by unauthorized modifications to this equipment. Such modifications could void the user's authority to operate the equipment.

This equipment complies with FCC radiation exposure limits set forth for an uncontrolled environment. This equipment should be installed and operated with minimum distance of [20] cm between the radiator and your body. This transmitter must not be co-located or operating in conjunction with any other antenna or transmitter.

This device contains licence-exempt transmitter(s)/receiver(s) that comply with Innovation, Science and Economic Development Canada's licence-exempt RSS(s). Operation is subject to the following two conditions:

- (1) This device may not cause interference.
- (2) This device must accept any interference, including interference that may cause undesired operation of the device.

This equipment complies with radio frequency exposure limits set forth by the Innovation, Science and Economic Development Canada for an uncontrolled environment. This equipment should be installed and operated with a minimum distance of 20 cm between the device and the user or bystanders.

This device must not be co-located or operating in conjunction with any other antenna or transmitter.

## **Declaration of conformity**

Trade Name: Toshiba

Model: 32V35MU / 32V35MC / 43V35MU / 43V35MC

Responsible Party: Hisense USA Corporation

Service Address: 105 Satellite BLVD Suite I, Suwanee, GA 30024

Service Phone Number: 1-888-407-0396





Manufactured under license from Dolby Laboratories. Dolby, Dolby Audio, and the double-D symbol are trademarks of Dolby Laboratories Licensing Corporation.



For DTS patents, see <http://patents.dts.com>. Manufactured under license from DTS Licensing Limited. DTS, DTS-HD Master Audio, DTS-HD, Virtual:X, and the DTS-HD logo are registered trademarks or trademarks of DTS, Inc. in the United States and other countries. © 2021 DTS, Inc. ALL RIGHTS RESERVED.



The terms HDMI and HDMI High-Definition Multimedia Interface, and the HDMI Logo are trademarks or registered trademarks of HDMI Licensing Administrator, Inc. in the United States and other countries.

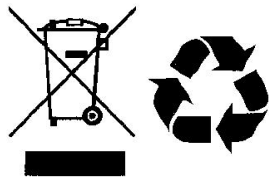

### Environmental Protection

This mark indicates that this product should not be disposed together with other domestic garbage, to avoid damage to the environment or human health due to the disposal of uncontrolled waste. Recycle it responsibly for promoting the sustainable reuse of material resources. To return your used device, please use the return systems available in your location or contact the vendor where you purchased your product they could take this product for recycling and protection of the environment.

©2023. All rights reserved.

THIS PRODUCT IS LICENSED UNDER THE AVC PATENT PORTFOLIO LICENSE FOR THE PERSONAL USE OF A CONSUMER OR OTHER USES IN WHICH IT DOES NOT RECEIVE REMUNERATION TO (i) ENCODE VIDEO IN COMPLIANCE WITH THE AVC STANDARD ("AVC VIDEO") AND/OR (ii) DECODE AVC VIDEO THAT WAS ENCODED BY A CONSUMER ENGAGED IN A PERSONAL ACTIVITY AND/OR WAS OBTAINED FROM A VIDEO PROVIDER LICENSED TO PROVIDE AVC VIDEO. NO LICENSE IS GRANTED OR SHALL BE IMPLIED FOR ANY OTHER USE. ADDITIONAL INFORMATION MAY BE OBTAINED FROM MPEG LA, L.L.C. SEE [HTTP://WWW.MPEGLA.COM](http://WWW.MPEGLA.COM)



39463-1315730-1111-1111

