

Hisense • Roku TV

32H4030F4

40H4030F4

43H4030F4

Quick Setup Guide

Help Hisense and Roku improve the environment by reducing paper waste. For detailed instructions and feature descriptions, access the full User Manual online at www.hisense-usa.com/support/.

1309368 ES-Y228103-1

Please read this Quick Setup Guide carefully before connecting your equipment and kindly keep it for future reference.

Your easy way to endless entertainment



Stream a massive selection of free, live and premium TV.*



Search across live and streaming channels†



Simple customizable home screen.



Roku mobile app#



Automatic software updates



Wireless connectivity

*Resolution is based on TV compatibility and varies by channel and content. Channels are subject to change, vary by region, and may require payment.

† Roku search is for movies and TV shows and does not work with all channels.

Limitations apply to the Roku mobile app. Please see support.roku.com for device compatibility information.



Disclaimer:

- This Quick Setup Guide is intended as a general guideline to help you set up your Hisense Roku TV. Images throughout this document are for illustrative purposes only and may differ from the actual product.
- Roku, Roku TV, the Roku logo, and the purple d-pad design are trademarks of Roku, Inc. All other trademarks and logos herein are the property of their respective owners.

WELCOME TO THE HISENSE FAMILY!

Congratulations on the purchase of your new Hisense Roku TV! This Quick Setup Guide will walk you through a few easy steps to set up your TV.

Because we value your business, we want to keep you in the know of 'all things Hisense'. Using your mobile phone, scan the Registration page QR code to register your TV. Depending on the make and model of your phone, you may need to download a QR code scanning app.

Country	Customer Care Center	Hisense Support Page	REGISTER YOUR TV
U.S.A	<ul style="list-style-type: none"> • Phone: 1-888-935-8880 • Hours of Operation: Monday - Friday: 9 AM to 9 PM EST Saturday - Sunday: 9 AM to 6 PM EST • Service Email: Service@hisense-usa.com 	<p>http://www.hisense-usa.com/support/</p> 	<p>http://www.hisense-usa.com/support/register</p> 

Packaged contents

Your package in which you purchased your new TV contains the following items:

- TV
- Remote Control
- Quick Setup Guide (this document)
- Important Safety Information and Warranty Card leaflet
- 2 AAA(1.5Vcc) batteries
- 2 stands
- 4 screws

IMPORTANT:

To prevent accidentally discarding items that came with your TV, be sure to **check ALL of the foam** in the carton box.

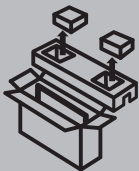

- Please check foam for accessories before discarding.
- Veuillez vérifier la mousse pour qu'il n'y ait pas d'accessoires avant de la jeter.
- Antes de desechar la espuma, asegúrese de retirar todos los accesorios.

STEP 1. Attach the TV stand or wall mount bracket (not included)

Attach the TV Stand

CAUTION:

- Be sure to disconnect the A/C power cord before installing a stand or Wall-Mount brackets.
- The LED display is very fragile and must be protected at all times when installing the stands. Be sure to protect the TV screen from getting scratched or damaged by any hard objects. In addition, DO NOT exert pressure on the TV screen at any time because it could crack.
- After the installation is complete, make sure the TV is steady on a table or firmly attached to a wall mount, before removing all protective film, if any.

To attach the stands:

1. Carefully place your TV face down on a soft, flat surface to prevent the TV from being damaged or the screen from getting scratched.
2. Take the 2 stands out of the foam and then align the stands with the screw holes located on the back of the TV.
3. Secure the stands with the screws in your accessory bag.

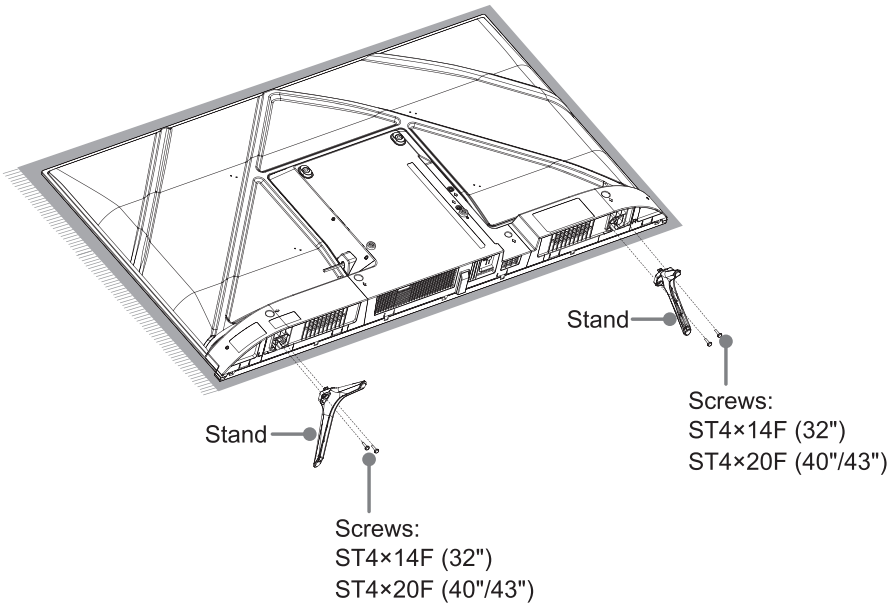

Attach the wall mount bracket (not included)

Before you begin the third-party manufacturer instructions, be sure to do the following things:

1. Place the TV face down on a clean, safe and cushioned surface.
2. Remove the TV stand if you have already attached it.
3. Place spacers (not included) in the corresponding bracket holes.

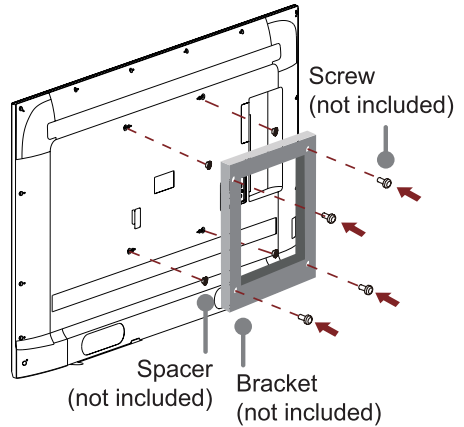

CAUTION:

- Follow instructions provided with the wall mount bracket. If it is not correctly mounted, the TV may fall and cause property damage or personal injury.
- When you attach the mount, be sure to use spacers (provided by the third-party manufacturer) between the TV and the bracket.
- To prevent internal damage to the TV and to ensure it is mounted securely, be sure to use fixing screws (not included) that are 8.0 - 10.0 mm in length when measured from the attaching surface of the rear cover.

8.0 - 10.0 mm

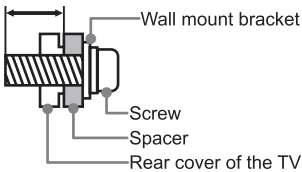

Wall mount hole pattern(mm)	100 × 200 (32") 200 × 200 (40"/43")
Wall mount screw size	M6

- We do not recommend hanging the TV on a slanted wall, and when wall mounting make sure your television remains parallel to the wall and does not lean forward.

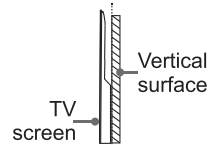

NOTE:

- If installed on a ceiling or slanted wall, or the television installed is not parallel to the wall, the television may fall and result in property damage or severe personal injury.
- If you have additional questions, please contact the wall mount manufacturer or the retailer from which you purchased the TV.
- The diameter and length of the screws differ depending on the wall mount bracket model.

STEP 2. Connect devices to your TV

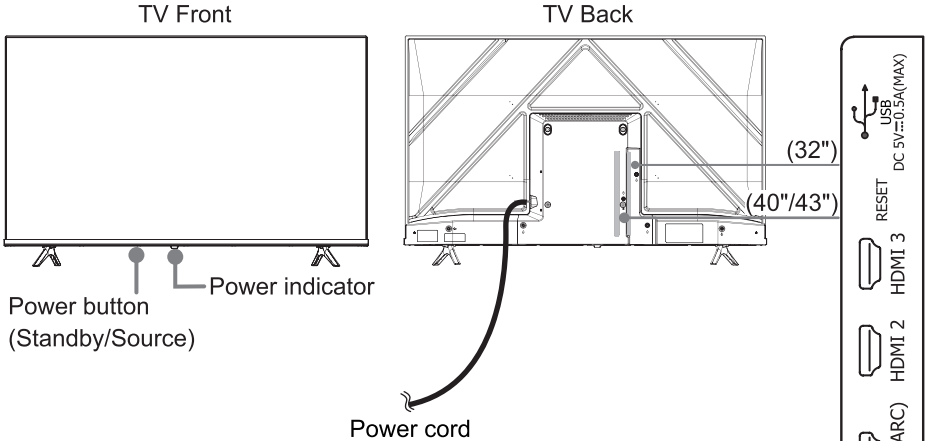

- **Power indicator:** The light is red in standby mode.
- **Power button (Standby/Source):** When the TV is in standby mode, press the power button, and TV will be turned on. When the TV is on, press the power button to call up the menu, press again to change the selection.
- **DIGITAL AUDIO OUT:** Connect an optical cable from an external digital audio system.
- **USB:** Connect a USB memory stick to enjoy its photos, music, and movies, or to enable Live TV Pause. Live TV Pause is only available on the Antenna input of your Roku TV and requires a dedicated USB 2.0 compatible flash drive with at least 16GB of storage. Live TV Pause requires connecting to the Roku service.
- **HDMI:** Connect a High Definition Multimedia Interface (HDMI) cable from an external device.
- **AV IN:** Connect a composite video cable and left-right audio cables from an external AV device.
- **RESET:** Restart or factory reset your TV.
- **HEADPHONE:** Connect headphones to hear audio from the TV. Headphones with microphones are not supported.
- **ANT/CABLE:** Connect an outdoor VHF/UHF antenna.



Buttons on your TV remote

The TV remote should feel right at home in your hand. We designed it to be incredibly intuitive for watching TV and navigating on-screen menus.

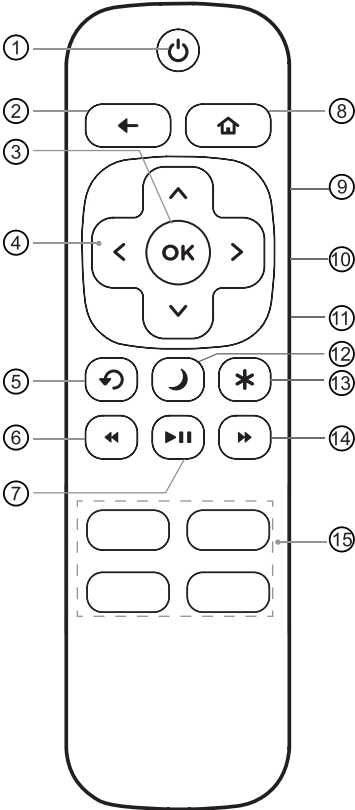

- ① **POWER:** Turn your TV on or off
- ② **BACK:** Return to the previous screen
- ③ **OK:** Select an option from a menu
- ④ **DIRECTIONAL KEYPAD:** The left arrow will bring up the antenna TV channel list or Smart Guide. The left and right arrows are used in Live TV Pause to select scenes.
- ⑤ **CHANNEL RECALL/JUMP BACK AND INSTANT REPLAY:** Change to the previous channel when viewing antenna or cable (no set-top box) programming
Jump back one position in video when viewing streaming content
Backspace one letter during menu entries, such as Search
- ⑥ **REWIND:** Rewind streaming video, jump to the previous audio track or selection, jump up one page in menus. This button is also used to rewind paused live TV using Live TV Pause
- ⑦ **PLAY/PAUSE:** Pause or resume playback. This button is also used to activate and use the Live TV Pause feature**
- ⑧ **HOME:** Display your TV's Home screen / Stop playback if you are watching TV or streaming content
- ⑨ **VOLUME UP (Side view):** Increase the volume or un-mute the sound
- ⑩ **VOLUME DOWN (Side view):** Decrease the volume
- ⑪ **MUTE (Side view):** Mute or un-mute the sound
- ⑫ **SLEEP:** Set the sleep timer
- ⑬ **VIEW MORE OPTIONS:** Give you easy access to picture settings, display options, and more / Press * on any screen to access options
- ⑭ **FAST FORWARD:** Fast forward streaming video, jump to the next audio track or selection, jump down one page in menus. This button is also used to fast forward paused live TV using Live TV Pause.
- ⑮ **PRE-SET STREAMING CHANNEL SHORTCUTS:**
When you press a pre-set channel button after the TV is connected to a Roku account:
 - If you have not installed the channel, it will display a sign up page
 - If you have installed the channel, it will display the channel's home page
 - If your TV is off, it will turn on your TV and display the channel's home page
 When you press a pre-set channel button before the TV is connected to a Roku account, there is no effect.

Disclaimer:

* Remotes may vary.
 ** A 16GB USB is required.
 Maximum playback of 90 minutes.

STEP 3. Begin using your remote

Power up your TV remote by inserting the included batteries.

CAUTION

- Dispose of the batteries in a designated disposal area. Do not throw them into a fire.
- Remove old batteries immediately to prevent them from leaking into the battery compartment.
- If you do not intend to use the remote control for a long time, remove the batteries.
- Battery chemicals can cause a rash. If the batteries leak, clean the battery compartment. If chemicals touch your skin, wash it immediately.
- Do not mix old and new batteries.
- Do not mix alkaline, standard (carbon-zinc) or rechargeable (for example, NiCd or NiMH) batteries.
- If your remote gets warm/hot during use, discontinue use and contact customer support immediately at www.hisense-usa.com/support.

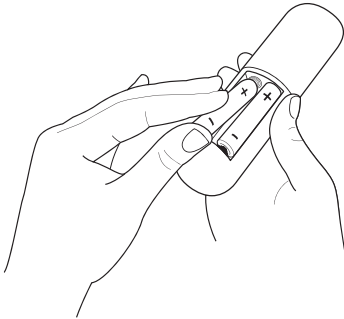

Using Your Cable Set-top Box or Satellite Receiver Remote as a 'Universal Remote'.

If you prefer to use your Cable Set-top Box or Satellite Receiver Remote as a 'Universal Remote', please refer to the manual that your cable or satellite service provided. It will include instructions on how to program their remote to your television. You can find codes that work with your Hisense Roku TV and the most common cable and satellite provider's universal remote control at www.roku.com/universalremote.

Turn on the TV

Connect the power cord to the power outlet.

Press the **Power**  button on the remote to turn on the TV. A startup screen appears that displays the **Hisense • Roku TV** logo.

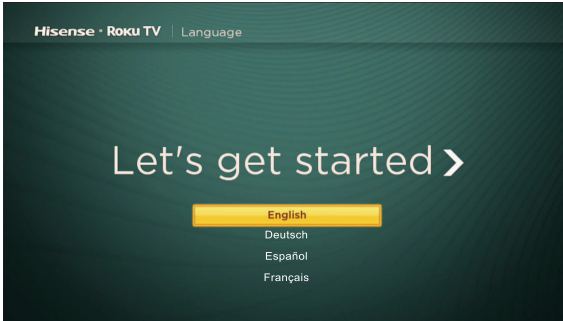

Choose **Set up for home use** to access all TV features and maximize low power.

NOTE: Only retailers that need to set up the TV for display should select **Set up for store use**.

Hisense Roku TV Text to Speech Functionalities

Text-to-Speech and Video Description functionalities on the TV

Text-to-Speech (TTS) and Video Description can help you to navigate the menus on the screen and hear an audio description of relevant programs. Text-to-Speech can convert written text into voice text to help visually impaired people listen to the information they are unable to read. In addition, the Video Description has an audio narration added to certain programs that will describe the main visual elements which visually impaired users may not be able to see.

Follow the steps below to enable the functions:

1. Press the **Home** button to access the **Menu**.
2. Next, select **Settings** to enter the Settings Menu.
3. Select **Accessibility** > **Screen reader** to turn the Screen reader **'On'** or **'Off'**.

When the Screen reader is turned 'On', then the contents of each menu displayed can be broadcasted out and you can hear the introduction of relevant programs.

<https://www.hisense-usa.com/hisense-roku-tv-text-to-speech-functionalities-2>



Connect your TV to the Internet to access thousands of streaming channels.

Make any night a movie night*

Access thousands of movies and TV episodes across major streaming services like Netflix, Hulu, HBO MAX, Showtime, and more. Choose from free, rental and subscription services.

Stream sports on the big screen

Choose from over 140 sports channels like ESPN, Red Bull TV and more.

Explore loads of free channels and free trials**

Your Hisense Roku TV has hundreds of popular free channels like The Roku Channel, ABC News, The CW and more. The Roku Channel features hundreds of Hollywood hits, all free and available to watch whenever you want. From comedies, to award winners, to cult classics and more. No fees. And no login required.

Explore your passions

Your Hisense Roku TV offers hundreds of streaming channels to fuel your passions – including fitness, kids & family, cooking, sports, religion, travel, International programming and more.

**Resolution is based on TV compatibility and varies by channel and content. Channels are subject to change, vary by region, and may require payment.*

***Cancel before the end of the free trial periods to avoid reoccurring monthly subscription fees. Credit card may be required. Free trials may only be available to new subscribers and other eligibility restrictions may apply.*

STEP 4. Complete guided setup and activation

Tip: Have your wireless network name and password handy.

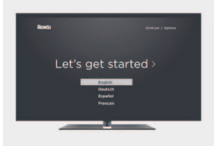

Follow the on-screen instructions on your Roku TV.

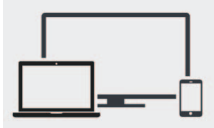

Activate your Roku TV using your computer, smartphone, or tablet to link to a Roku account. You need a Roku account to activate your Roku TV and access entertainment across thousands of streaming channels.

NOTE: Roku doesn't charge for activation support – beware of scams.

Roku accounts are free and while a valid credit card number is not required to create a Roku account, saving your credit card information makes renting, purchasing, and subscribing to entertainment from the Roku Channel Store fast and convenient.

Once connected to your account, your TV will automatically update with the latest software, and you can start streaming immediately.

If you aren't ready to connect your TV to a wireless network, you can still use it as a regular TV.

Complete the rest of the on-screen prompts and setup is done. Congratulations!

NOTE: Once you're connected, your TV will automatically update with the latest software—plus you can start streaming the entertainment you know and love. Unlike other TVs, your new **Hisense Roku TV** automatically receives regular software updates in the background when it's connected to the Internet. This allows it to give you a better experience. For more information on setting up and using your Roku TV features, go to <https://support.roku.com/>.

All software, applications, services and content accessible through the Television belong to providers who are not controlled by or affiliated with Hisense, are protected by copyright, patent, trademark and/or other intellectual property laws and are the sole property of their respective owners. Software, applications, services and content accessible through the Television are at the sole discretion and control of such providers and are completely outside Hisense's control. These services and/or content may be unavailable, discontinued or suspended by such providers, temporarily or permanently, at any time, without liability and without notice to you. HISENSE AND ROKU EXPRESSLY DISCLAIM ANY AND ALL RESPONSIBILITY FOR THE AVAILABILITY, CONTINUITY OF SERVICE, OR THE CONTENT PROVIDED BY ANY OR ALL SUCH PROVIDERS.

STEP 5. Personalize your Home screen

Easily switch between streaming channels and inputs.

The home screen menu lets you access a ton of streaming entertainment, search for streaming movies and TV shows and change your settings.

The grid of tiles on the right lets you visually choose among your favorite streaming channels and the inputs where you have attached devices such as a DVR, game console, antenna, or set top box.

You can easily rearrange the order of the tiles on the Home screen to suit your viewing preferences. Highlight the tile you wish to move and press the * button on your Roku TV remote.

STEP 6. Optional

Watching local broadcast TV? How do you scan for channels?

If you connected your TV to an antenna or cable wall jack (no box):

1) When the setup wizard is complete, select the Live TV icon  from the home screen.

2) Follow the on-screen instructions.

3) Whenever you want to watch local broadcast TV, select the Live TV icon .

4) Connect a USB memory stick to enjoy photos, music and movies or to enable Live TV Pause. Live TV Pause is only available on the Antenna input of your Hisense Roku TV for up to 90 minutes when connected to a dedicated USB 2.0 compatible flash drive with at least 16GB of storage.

Product specifications



MODEL NAME		32H4030F4
Dimension (W x H x D)	Without Stand	28.6 × 16.9 × 3.3 inches (726 × 430 × 84 mm)
	With Stand	28.6 × 18.6 × 6.3 inches (726 × 472 × 159 mm)
Weight	Without Stand	8.2 lbs (3.7 kg)
	With Stand	8.4 lbs (3.8 kg)
DISPLAY		
Active Screen Size (Diagonal)		31.5 inches
Screen Resolution		1366×768
Panel Selected		High Definition backlight
POWER		
Power Supply		AC 120V, 60Hz
Standby Consumption		Less than 0.5W
Audio Power		6W + 6W
CHANNELS & SIGNALING		
Receiving Channels		VHF: 2 - 13, UHF: 14 - 69, CATV: 1 - 125 Digital Terrestrial Broadcast (8VSB): 2 - 69 Digital cable (64/256 QAM): 1 - 135
Tuner Type		Frequency synthesized
Receiving System		Analog: NTSC Digital: ATSC/QAM
OTHER FEATURES		
HDMI Input		RGB/60Hz (640×480, 800×600, 1024×768) YUV/60Hz (480i, 480p, 720p, 1080i, 1080p)
HD Supported Definitions		480i, 480p, 720p
Environmental Conditions		Temperature: 41°F - 95°F (5°C - 35°C) Humidity: 20% - 80% RH Atmospheric pressure: 86 kPa - 106 kPa
Storage Temperature		5°F to 113°F (-15°C to 45°C)
Storage Humidity		10% to 70%, non-condensing

Product specifications

MODEL NAME		40H4030F4	43H4030F4
Dimension (W x H x D)	Without Stand	35.4 × 20.3 × 3.3 inches (900 × 515 × 85 mm)	38.0 × 22.2 × 3.5 inches (965 × 563 × 88 mm)
	With Stand	35.4 × 22.2 × 7.2 inches (900 × 565 × 182 mm)	38.0 × 24.1 × 7.2 inches (965 × 611 × 182 mm)
Weight	Without Stand	11.9 lbs (5.4 kg)	13.4 lbs (6.1 kg)
	With Stand	12.1 lbs (5.5 kg)	13.7 lbs (6.2 kg)
DISPLAY			
Active Screen Size (Diagonal)		39.5 inches	42.5 inches
Screen Resolution		1920×1080	
Panel Selected		Full High Definition backlight	
POWER			
Power Supply		AC 120V, 60Hz	
Standby Consumption		Less than 0.5W	
Audio Power		7W + 7W	
CHANNELS & SIGNALING			
Receiving Channels		VHF: 2 - 13, UHF: 14 - 69, CATV: 1 - 125 Digital Terrestrial Broadcast (8VSB): 2 - 69 Digital cable (64/256 QAM): 1 - 135	
Tuner Type		Frequency synthesized	
Receiving System		Analog: NTSC Digital: ATSC/QAM	
OTHER FEATURES			
HDMI Input		RGB/60Hz (640×480, 800×600, 1024×768) YUV/60Hz (480i, 480p, 720p, 1080i, 1080p)	
HD Supported Definitions		480i, 480p, 720p, 1080i, 1080p	
Environmental Conditions		Temperature: 41°F - 95°F (5°C - 35°C) Humidity: 20% - 80% RH Atmospheric pressure: 86 kPa - 106 kPa	
Storage Temperature		5°F to 113°F (-15°C to 45°C)	
Storage Humidity		10% to 70%, non-condensing	

Quick problem-solving tips

When you experience an issue with your TV, turn it off and on again. If this does not resolve the problem, then refer to the tips below. If the problem is still not resolved, then contact us at one of the phone numbers on Page 2.

SOUND OR PICTURE ISSUES	POSSIBLE SOLUTIONS
<p>You do not see a picture when turning on the TV</p>	<ul style="list-style-type: none"> • Check if the LED light is on. If it is, then there is power to the TV. • The TV may be in Standby mode. Press the Power  button on the remote control to activate the unit from Standby. • Check if the power cord is plugged into an active electrical outlet.
<p>You have connected an external source to your TV but can not find it on the Home screen</p>	<ul style="list-style-type: none"> • Make sure your external source is turned on. • Check to see if the correct input tile is selected on the Home screen for the external source you want to view. • Check to see if the external source device connection is snug and fully inserted into the TV port.
<p>When you turn on your TV, there is a delay for a few seconds before the picture appears</p>	<ul style="list-style-type: none"> • This is normal. If you have already set up your TV, it is initializing and searching for previous setting information.
<p>You see a normal picture but do not hear any sound</p>	<ul style="list-style-type: none"> • Check that volume is turned up. • Check if "Mute" mode is ON. Turn off mute by pressing the Mute * button again, or pressing volume up.
<p>You hear sound but picture color is faded or in black and white</p>	<ul style="list-style-type: none"> • Check that the Color value is set to 50 or greater. • Check the color on another channel or input tile.
<p>Your sound or picture is distorted or appears wavy</p>	<ul style="list-style-type: none"> • Turn off and/or remove any electrical appliance that may be nearby the TV panel. • Insert the power plug of the TV set into another power outlet.
<p>Your sound or picture is blurry or cuts out</p>	<ul style="list-style-type: none"> • If you are using an external antenna, check the connections for a snug and tight fit. • Adjust or reposition the antenna placement.
<p>You see horizontal/vertical stripes on the picture, or it is shaking</p>	<ul style="list-style-type: none"> • Turn off and/or remove any electrical appliance that may be nearby the TV panel. • Insert the TV power cord into another electrical outlet.

Quick problem-solving tips (continued)

CONNECTIVITY ISSUES	POSSIBLE SOLUTIONS
You cannot connect to your wireless network	<ul style="list-style-type: none">• From the Roku TV home screen, press the Directional Keypad down arrow to Settings. Press OK on the Directional Keypad. Press OK to select Network. Press the bottom Directional Keypad arrow to Check Connection. Press OK to Check connection• For additional help, visit www.hisense-usa.com/support.
REMOTE CONTROL ISSUES	POSSIBLE SOLUTIONS
Your remote control is not responding to button presses	<ul style="list-style-type: none">• Check that the TV is still on.• Check that the batteries are good and are inserted properly.• Check that there are no obstacles between the remote control and the front of the TV.• Try moving closer to the TV. If the LED on the TV flashes when you press any of the buttons on the remote control, the issue is not with the remote control.

Certification and Compliance

NOTE: The following warnings only apply to products with such certification.

This device complies with Part 15 of the FCC Rules. Operation is subject to the following two conditions: (1) This device may not cause harmful interference, and (2) This device must accept any interference received, including interference that may cause undesired operation.

Note: This equipment has been tested and found to comply with the limits for a Class B digital device, pursuant to Part 15 of the FCC Rules. These limits are designed to provide reasonable protection against harmful interference in a residential installation. This equipment generates, uses, and can radiate radio frequency energy and, if not installed and used in accordance with the instructions, may cause harmful interference to radio communications. However, there is no guarantee that interference will not occur in a particular installation. If this equipment does cause harmful interference to radio or television reception, which can be determined by turning the equipment off and on, the user is encouraged to try to correct the interference by one or more of the following measures:

- Reorient or relocate the receiving antenna.
- Increase the separation between the equipment and receiver.
- Connect the equipment into an outlet on a circuit different from that to which the receiver is connected.
- Consult the dealer or an experienced radio/TV technician for help.

The manufacturer is not responsible for any radio or TV interference caused by unauthorized modifications to this equipment. Such modifications could void the user's authority to operate the equipment.

This equipment complies with FCC radiation exposure limits set forth for an uncontrolled environment. This equipment should be installed and operated with minimum distance of [20] cm between the radiator and your body. This transmitter must not be co-located or operating in conjunction with any other antenna or transmitter.

Declaration of Conformity

Trade Name: Hisense

Model: 32H4030F4 / 40H4030F4 / 43H4030F4

Responsible Party: Hisense USA Corporation

Service Address: 105 Satellite BLVD Suite I, Suwanee, GA 30024

Service Phone Number: 1-888-935-8880

This device complies with Part 15 of the FCC Rules. Operation is subject to the following two conditions: (1) this device may not cause harmful interference, and (2) this device must accept any interference received, including interference that may cause undesired operation.



Manufactured under license from Dolby Laboratories. Dolby, Dolby Audio, and the double-D symbol are trademarks of Dolby Laboratories Licensing Corporation.



The terms HDMI and HDMI High-Definition Multimedia Interface, and the HDMI Logo are trademarks or registered trademarks of HDMI Licensing Administrator, Inc. in the United States and other countries.



©2023. All rights reserved. Hisense and the Hisense logo are registered trademarks of Hisense. Other brand and product names are registered trademarks of their respective owners.

THIS PRODUCT IS LICENSED UNDER THE AVC PATENT PORTFOLIO LICENSE FOR THE PERSONAL USE OF A CONSUMER OR OTHER USES IN WHICH IT DOES NOT RECEIVE REMUNERATION TO (i) ENCODE VIDEO IN COMPLIANCE WITH THE AVC STANDARD ("AVC VIDEO") AND/OR (ii) DECODE AVC VIDEO THAT WAS ENCODED BY A CONSUMER ENGAGED IN A PERSONAL ACTIVITY AND/OR WAS OBTAINED FROM A VIDEO PROVIDER LICENSED TO PROVIDE AVC VIDEO. NO LICENSE IS GRANTED OR SHALL BE IMPLIED FOR ANY OTHER USE. ADDITIONAL INFORMATION MAY BE OBTAINED FROM MPEG LA, L.L.C. SEE [HTTP://WWW.MPEGLA.COM](http://www.mpegla.com)

