

Hisense

43A6N

50A6N

55A6N

65A6N

USER MANUAL

Before using the TV, please read this manual thoroughly and retain it for future reference.

English

1403794 RSAG2.025.53307SS B





Tips

Before using the TV, please read this manual thoroughly and retain it for future reference. Our company does not assume any liability for any accident arising from violation of the matters of attention and instruction on use in this manual.



This product involves high voltage. The user may not open the cabinet without authorization. Any person other than the repairer may not repair and replace parts without authorization to avoid shock and fire accidents.



Please clean and maintain the entire TV set with clean and soft cotton cloths, and repeated forcible cleanings are prohibited.

The screen may not be scribed, tapped, impacted with hard objects or rubbed with any grinding materials.

During placement and use, the product should be kept from water droplet and splash. In case of adverse weather e.g. thunderstorm, the power plug and cable TV (or outdoor antenna) plug shall be rapidly pulled off to avoid damage due to lightning strike.

Still images can result in permanent damage to TV screen.

1. The time for displaying static images on the LCD TV screen may not exceed 2 hours, otherwise it will result in residual image on the screen. To avoid this, you need to lower the screen brightness and contrast when displaying the still images.
2. When viewing 4:3 format program over long time, different traces will be left on the left and right sides of the screen and the edge of margin. So the user is advised not to use such pattern over long time.
3. Long-time display of electronic games and computer static images may result in local residual image, and the screen may get burnt and result in residual image on the screen. To avoid this, you need to lower the screen brightness and contrast during use.

For any image residual shadow, local residual image and trace problems with the TV screen due to the said reasons, the display screen is not within the range of warranty.

The TV set is a Type II equipment, and used without requiring grounding.

Tips for energy saving:

1. Please choose AC power off (pull out the plug) when not viewing TV program to minimize energy consumption.
2. Under condition that the view quality is not impacted, reduce the brightness of display screen to minimize the energy consumption of TV during use.



Important Safety Instructions

Check the Symbol



Triangle enclosing a lightning arrow is a warning symbol, reminding you of the high voltage danger in the product.



Triangle enclosing an exclamation mark is a warning symbol, reminding you of the important notes related to the product.

- Attention.



The correct way.



The wrong way.



Next step.

Alerts: Before using the product, please read the following clauses carefully.

1 Power and signal

⚠ When it is rainy, please pull out the power plug, CATV plug or outside antenna plug to avoid any possible damage to the TV set. Do not touch the inducting wire of the antenna.

⚠ Where the MAINS plug or an appliance coupler is used as the disconnect device, the disconnect device shall remain readily operable.

⚠ If you do not use the product for a long time, please pull out the power plug.

⚠ If you find abnormal sound or smell, or there is sound but no image, please turn off the TV and pull out the plug immediately and contact the Hisense Service.

- Please do not press the power line and signal line with other things.
- Please do not make the power outlet overloaded, or it will result in the danger of fire.
- Keep the power line away from high temperature and heating things.
- There are some changes for the outdoor antenna if it stays outside for a long time, which may affect the picture quality of the TV, so please check the antenna or replace it regularly.
- Do not place containers with water on the TV, such as a cosmetic or medicament.
- If foreign objects or water falling into the television, unplug the power cord timely and call Hisense Services.
- Beware of children standing on top of a TV or climb to the television.
- After the TV from the cold to a warm area where, for the full distribution of drying condensation inside the machine, you should place some time after the power is turned on.
- To prevent injury, you must follow the installation instructions of the device after the installation base, placed on a horizontal table, or is not installed base, use can be fixed to the wall after wall mounting.
- Do not expose the battery to sunshine, fire and other excessive heat, or there will be an explosion hazard.
- As the plug on the power cord is used as disconnect device, the output socket of the plug should be installed in an easy-to-touch place.

2 Maintenance

- Do not clean this unit with volatile oils or dilution, which may cause cabinet deterioration or damage its coating surface.
- If the cabinet becomes dirty, please clean it with a soft cloth which has neutral detergent wet with water.

3 LCD display instruction and maintenance

△ LCD display panel is the advanced S&T product, composed of several millions of Movie transistors inside. There can be dark or bright spots appearing on the panel. please note that this is a normal phenomenon, which does not affect the overall performance.

The incorrect maintenance will lead to damage to the LCD screen, which will affect the image effect, so you must pay attention to the following items:

- △ Don't clean the screen with the organic solvents, such as alcohol, gasoline, etc. or chemical reagents ,such as acid, alkali, etc.
- △ Do not clean the screen with any kind of detergent.
- △ After the TV is turned off, you, when necessary, can clean the screen with a clean and soft cotton cloth to properly safeguard it, but repeatedly cleaning with force is prohibited.
- Please do not directly touch the screen with your fingers, which may damage the screen surface. What's more, the oil and fat on the screen is difficult to remove.
- Please do not put pressure on the LCD, for the LCD screen is delicate and vulnerable.
- The hard object is not allowed to touch the LCD screen, for it is easily scratched.

4 Product

- Please do not try to decompose any part of the product, which may cause damage to the product as well as harm to the human. And it will also make you face the product warranty failure.
- Please do not remove the back cover. The adjust and check inside the unit should only be carried out by the professional technicians.
- Please do not cover or block the heat-radiating holes in order not to hamper the unit to give off heat.
- Please do not stick the sharp objects, metal, or liquid into or use them to touch the signal interface or heat-radiating holes in case of short circuit or damage to the product.

5 Method of placement

- √ Even and steady occasions.
- × Places under direct sunshine or close to heating devices.
- × Places with poor ventilation.
- × Places close to furnace or places to which water, oil or smoke is easy to enter.
- × Places where ventilating openings are closed.
- × Unsteady places.

- × Places suffering from easy vibration.
- × Places of lot of dust or moist places.
- × Places of high temperatures.
- In the case where such substances that are painted with paint or organic solvent and grease, etc. on the surface of the TV cabinet, the chemical reaction may be occurred in between the rubber cushion on the base and such substances hereinbefore, which may cause a slight corrosion on the surface of the TV cabinet. Therefore, users are recommended to firstly put a layer of protective material (such as pressboard or glass sheet, etc.) on the TV cabinet and then place the TV set.

6 Watching TV

- Watch TV at a proper distance, and the best distance is 3 to 4 times the length of the vertical distance of LCD.
- Keep the lighting indoors bright enough to read newspaper.
- The volume should be properly set in order not to disturb your neighbors, esp. when it is during the night.

7 Others

- It is recommended that 2 or more people should load, unload and carry the unit; try to avoid any crash when carrying the unit, and protect the LCD screen in particular.
- If you touch the LCD screen when turning on or off the TV, you can feel the slight electric shock, which is the so-called electrostatic and does no harm to your health.
- Plastic shell newly purchased television, internal transformer insulating paint, rubber and other pieces of furniture will be like a new purchase as distributing certain smell, temperature, odor will be more apparent. The odor is determined by the nature of the material. Materials scheme we use fully meet the requirements of environmental regulations sales regions, so consumers can be assured. TV odors over time gradually reduce and eventually disappear, consumers should pay attention to use ventilation environment.

8 Securing the Installation Space

- Never cover or block the heat-radiating holes.
- Avoid operating the TV below 5 °C.
- Make sure that your TV has adequate air circulation. Allow enough space around the TV as shown below.

Install with stand:

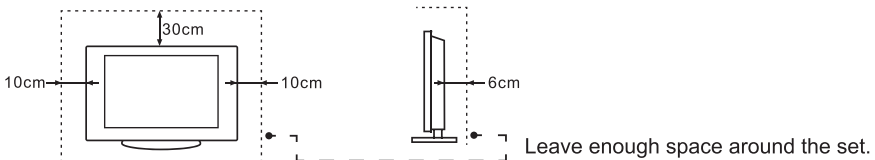

Install on the wall:

We do not recommend hanging the TV on a slanted wall, and when wall mounting make sure your television remains parallel to the wall and does not lean forward.

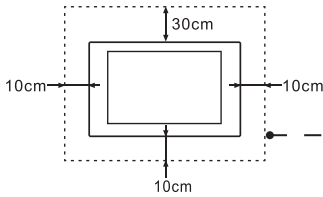

----- Leave enough space around the set.

- Never install the TV set as follows:

Inadequate air circulation can lead to overheating of the TV and may cause damage to your TV or cause fire.

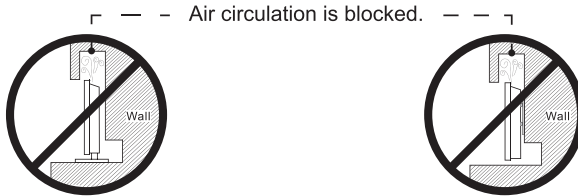

Warning

Never place a television set in an unstable location. A television set may fall, causing serious personal injury or death. Many injuries, particularly to children, can be avoided by taking simple precautions such as:

- ALWAYS use cabinets or stands or mounting methods recommended by the manufacturer of the television set.
- ALWAYS use furniture that can safely support the television set.
- ALWAYS ensure the television set is not overhanging the edge of the supporting furniture.
- NEVER place the television set on tall furniture (for example, cupboards or bookcases) without anchoring both the furniture and the television set to a suitable support.
- NEVER place the television set on cloth or other materials that may be located between the television set and supporting furniture.
- ALWAYS educate children about the dangers of climbing on furniture to reach the television set or its controls.
- ALWAYS route cords and cables connected to your television so they cannot be tripped over, pulled or grabbed.
- NEVER place items that might tempt children to climb, such as toys and remote controls, on the top of the television or furniture on which the television is placed.

If your existing television set is being retained and relocated, the same considerations as above should be applied.

 AC voltage: This symbol indicates that the rated voltage marked with the symbol is AC voltage.

 Class II product : This symbol indicates that it does not require a safety connection of protective earthing (ground).



Contents

Accessories List.....	1
Installation	1
Remote Control	4
Control Panel.....	6
Terminal Introduction	7
Connection Description	8
Using the TV for the First Time.....	11
Others.....	12
Specifications	14



1 Accessories List

- | | | | |
|-------------------------------------------------------------|------------------|-------------------|------------|
| User Manual ×1 | Warranty Card ×1 | Remote Control ×1 | Battery ×2 |
| Power Cord ×1 | Base Stand ×2 | Screw ×4 | |
| Nut ×2(for installing the wall mount bracket) (50"/55"/65") | | | |



2 Installation

Installing the Stand

- The display on your TV is fragile, Make sure the TV screen is not scratched or damaged by hard objects or from pressure.
- Install the base stand with the provided screws in the accessory bag in case of causing damage to TV.

- 1 Carefully place your TV facedown on a soft, flat surface to prevent damage to the TV or scratching to the screen.
- 2 Remove the 2 stands from the accessory bag and then insert the stands into the bottom slots of the TV.
- 3 Secure the BASE STAND to the TV with the 4 screws in accessory tightly.

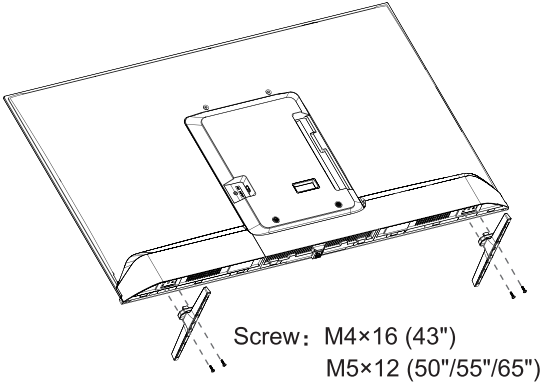

Installing the Wall Mount Bracket

Before you follow the instructions to attach the wall mount, be sure to do the following things:

1. Place the TV on a clean, safe and cushioned surface.
2. Remove the TV stands if you have already attached them.
3. Take the nuts out of the accessory bag and tighten the nuts into the holes of the back cover (See Fig. 1). (only for 50"/55"/65")
4. Place spacers (not included) between the TV and the bracket (See Fig. 2).

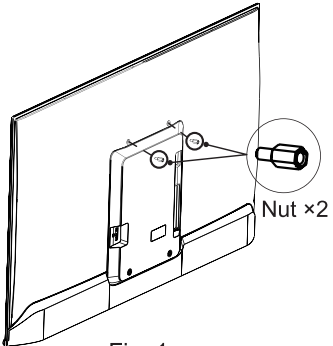

Fig. 1

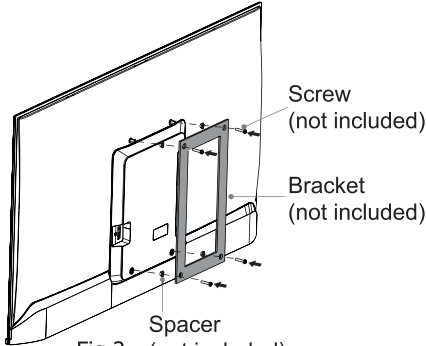

Fig.2 (not included)

CAUTION

When mounting the TV on a wall, follow instructions provided with the wall mount bracket. If it is not correctly mounted, the TV may fall and cause property damage or personal injury.

- Be sure to use the wall mount bracket with four fixed points.
- Place spacers between the TV and bracket.
- Standard dimensions are shown below.

Wall mount hole pattern (mm)	200 × 300 (43") 200 × 400 (50"/55") 300 × 400 (65")
Wall mount screw size	M6

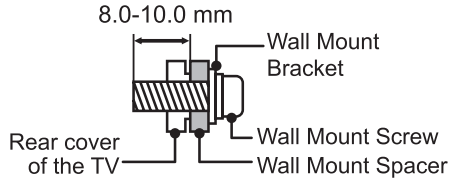

- We do not recommend hanging the TV on a slanted wall, and when wall mounting make sure your television remains parallel to the wall and does not lean forward.

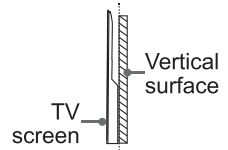

【 NOTE 】

- The diameter and length of the screws differ depending on the wall mount bracket model.
- Wall mount bracket is optional. Your TV may not have wall mount bracket. Please refer to the actual accessories.

3

Remote Control

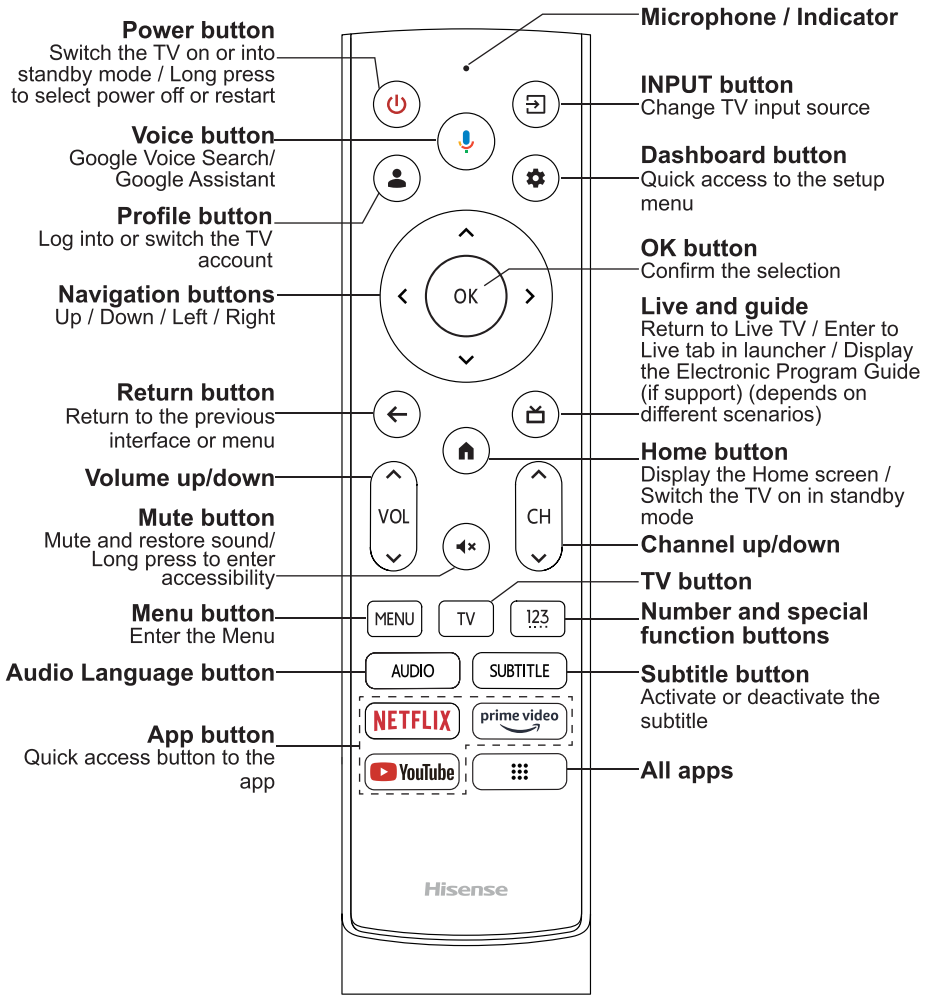

The effective range of remote control

- The remote control can work at a distance of up to 8 meters in front of the TV set.
- The remote control angle: taking the remote sensor as an apex, 6 meters away, its controlled horizontal angle is within $\pm 30^\circ$, while the vertical angle is within $\pm 15^\circ$.

How to replace battery

- 1 Slide the back cover to open the battery compartment of the remote control.
- 2 Insert two AAA size batteries. Make sure to match the (+) and (-) ends of the batteries with the (+) and (-) ends indicated in the battery compartment.
- 3 Close the battery compartment cover.

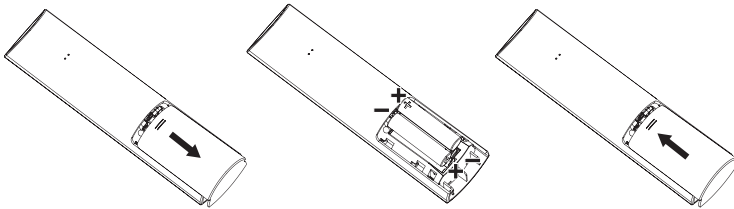

Attention

- 1 If the remote control doesn't work normally, unstable, or cannot control the TV, change the batteries.
- 2 If you do not intend to use the remote control for a long time, remove the batteries. Remove depleted batteries immediately to prevent battery acid from leaking into the battery compartment. (Used batteries pollute the environment, properly handle.)

Pairing the Remote Control

- 1 Pair the remote to the TV after you power it on. Keep the remote control within 3 metres from the TV. Press and hold the **← Return button** and **🏠 Home button** at the same time for at least 3 seconds to start pairing.
- 2 If the remote pairs successfully, a confirmation will display on the screen. If it does not pair successfully, an unsuccessful message will display. Please repeat step 1.

【 NOTES 】

- If an unknown error occurs with the remote, it could have been caused by interference. Try to remove what's causing the interference and pair the remote again.
- If an unknown error occurs with the remote control while the battery power is normal, you can take out the batteries and press any key for 1~2 seconds, and insert them back. The remote control can work normally.
- The remote cannot be paired to the TV while the TV is in the standby mode.

4

Control Panel

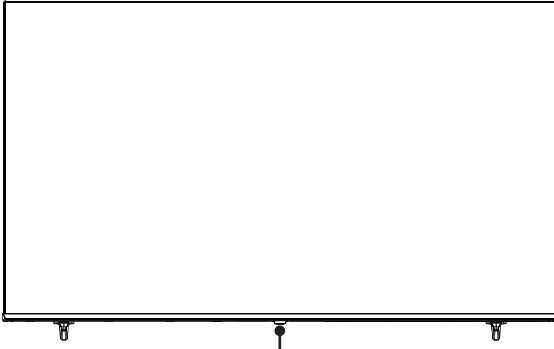

Single button / Power indicator / Remote sensor

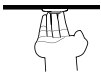
Item	Description
Remote sensor	Receives remote signals from the remote control.
Power indicator	The light is white in standby mode.
 Single button (Power/Source)	<ul style="list-style-type: none"> ▶ When the TV is in standby mode, press the single button to turn on the TV. ▶ When the TV is turned on, press the single button to pop up the menu. Move the focus to select among standby mode, input signal sources and other options. Long press the single button to make a selection.

【NOTE】

- Powering on the TV requires several seconds to load programs. Do not rapidly turn the TV off as it may cause the TV work abnormally.

5

Terminal Introduction

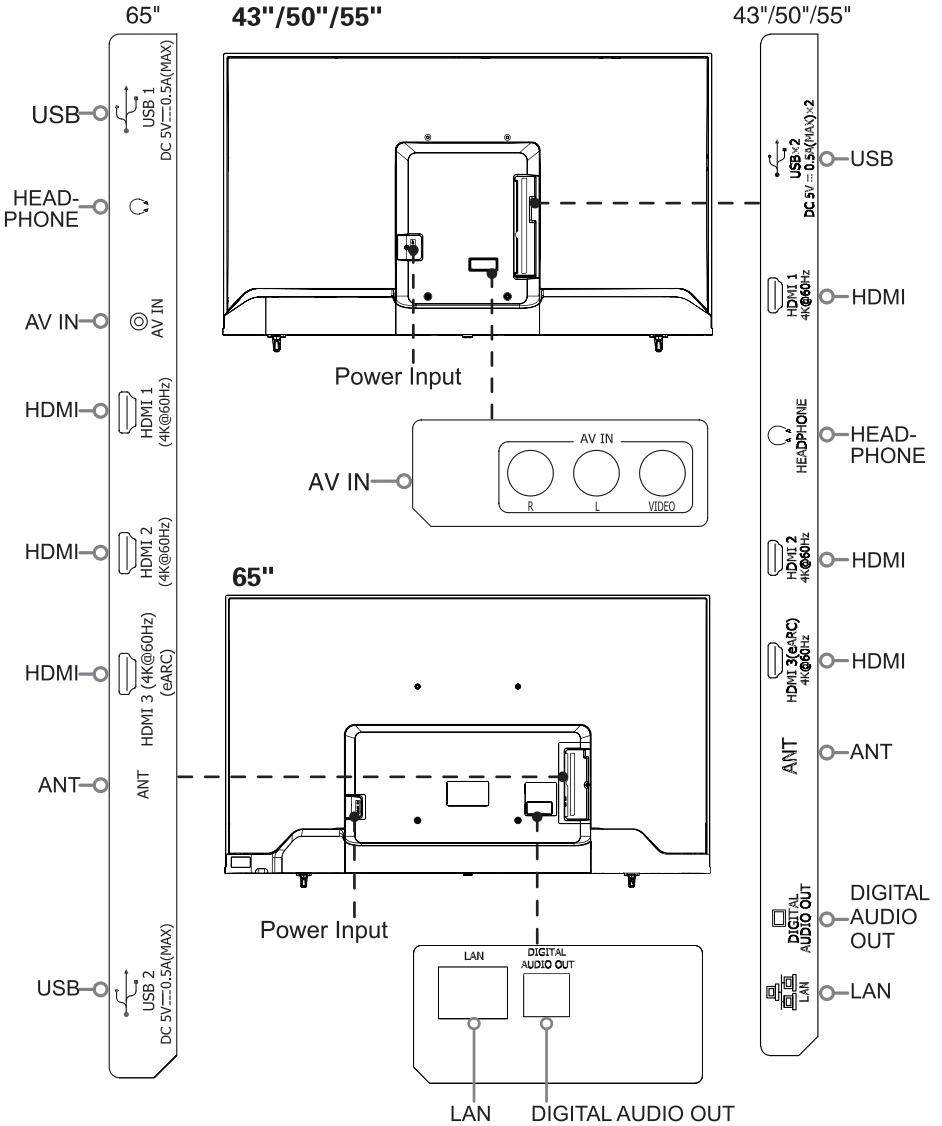

【NOTE】

- Some external devices can not connect to the TV under some circumstances. Please replace with appropriate external signal cable or use the adapter that match with the port in such case.

6

Connection Description

- **Selecting signal input**

Press the  **INPUT button** to enter the inputs menu, select the local port corresponding to the signal source in the interface.

- **Connecting an Antenna or Cable**

For the first time to enter the LiveTV by pressing the **TV button**, you can select receive broadcast signal through Bind signal (Set-top box) or Scan All (Digital TV-DTMB / Analog TV signal).

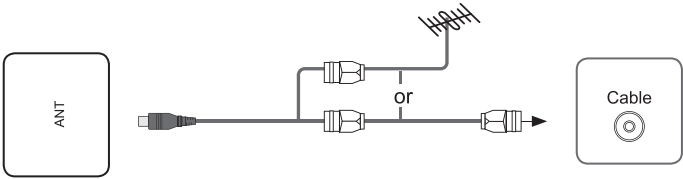

- **Connecting a USB Device**

The total current should be no more than 1000 mA when all the USB ports are connected with external devices. Hisense warranty does not cover the TV damages and issues caused by the current overload.

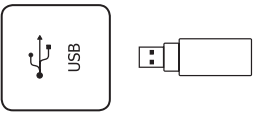

- **Connecting an Ex-Speaker**

DIGITAL AUDIO OUT: Use a optical cable to connect the TV's DIGITAL AUDIO OUT port to the Audio Amplifier, then connect the Audio Amplifier to the external speaker.

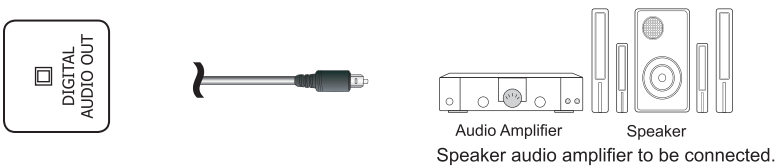

Speaker audio amplifier to be connected.

• **Connecting a Headphone**

While the headphone is connected, the sound from the built-in speakers will be disabled.

Headphones can be connected to the HEADPHONE jack on the TV.

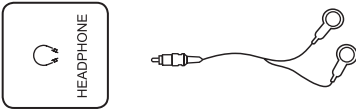

• **Connecting an AV Device**

With the HDMI Cable

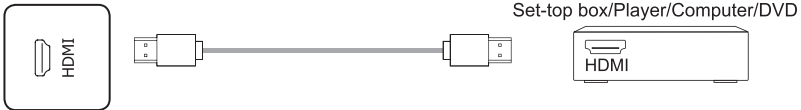

【 NOTE 】

- For video format supported by HDMI input, refer to the Specifications.

With the AV Cable

43"/50"/55"

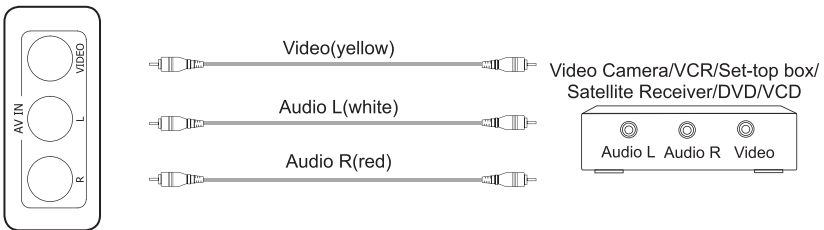

65"

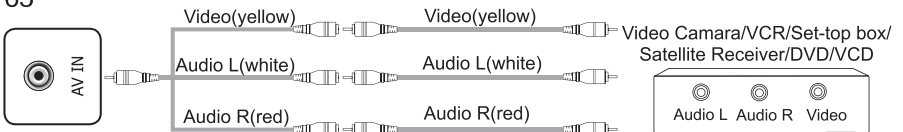

【 NOTE 】

- Please make sure that the audio is connected, otherwise the sound will be abnormal.

- **Connecting a network**

Press the **Dashboard button** to enter the setup menu. Select **Settings** and press the **OK button** to enter the menu. Select Network & Internet option in the menu and press the **OK button** to enter the Internet settings menu.

The wireless network connection

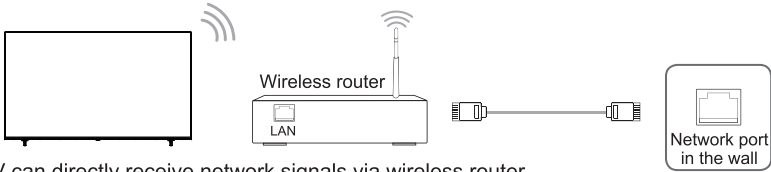

The TV can directly receive network signals via wireless router.

- 1 In **Network and Internet**, select an available network, input password and click ✓ in the onscreen keyboard to connect. (If the network is not encrypted, select the network and the TV will connect to it directly.)
- 2 If the network you want to connect does not appear in the list. select **Add new network** and enter the name of Wi-Fi network manually. Select the appropriate type of security, input password and click ✓ in the onscreen keyboard.

The wired network connection

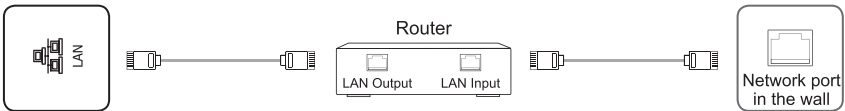

Connect your TV to your network by connecting the LAN port on the back of your TV to an external modem or router using a LAN cable.

7

Using the TV for the First Time

1 Turning the TV On or Off

- Use an AC cord to connect the TV's Power input port AC outlet.
- Press the **⏻ Standby button** on the remote control to turn on the TV, then complete the Setup Wizard menu according to the boot navigation prompt (The navigation information is specific to the actual condition).
- When the TV is on, press the **⏻ Standby button** on the remote control, and the TV will enter Standby mode. Press this button again, and you can watch TV normally.
- Please remove the plug from the AC outlet when not viewing TV for a long time.

【NOTE】

- If the TV is turned off , to turn it on again, please wait 5 seconds at least in case the abnormal phenomena occurred.

2 Adjusting the TV settings

Menu is an easy interactive window to achieving most of the basic functions of the TV.

- Press the **⚙ Dashboard button** to display the Settings menu and you can adjust various settings.
- In each level of menu, you can select the following operations according to different menus:

Press **Navigation button** to select an item.

Press the **OK button** to confirm operation or enter the submenu.

Press the **Left or right button** to adjust the value.

Press **Up or down button** to select the item.

- Press the **← button** to return to the previous menu or exit the menu.

8

Others

1 Trouble Shooting

When there is something wrong with your TV, you can try turning off the TV and then restart it.

You can also operate according to the following chart. If the problem still cannot be solved, please contact the professional technicians.

Symptoms	Possible Solutions
No sound or picture	<ul style="list-style-type: none">• Check if the power line is in the outlet and if it has electricity.• Check if you have pressed Power button on the TV or Power button on the remote control.• Check the volume settings or whether TV be muted.
The sound and picture are interfered	<ul style="list-style-type: none">• Try to find the appliance affecting TV set, and move it far away from the TV set.• Try to insert the power plug of the TV set into another outlet.
Unclear picture or picture with snow	<ul style="list-style-type: none">• Check the direction, position and connection of your antenna.• Adjust the direction of your antenna or reset or fine tune the channel.
The remote control does not work	<ul style="list-style-type: none">• Change the batteries in the remote control.• After removing the battery, press a few keys and then reinstall the battery.• Check the contacting points of the batteries.• Check if there is obstruction between the remote control and the monitor.• Check if the batteries are correctly installed.

2 Instructions



The terms HDMI, HDMI High-Definition Multimedia Interface, HDMI Trade dress and the HDMI Logos are trademarks or registered trademarks of HDMI Licensing Administrator, Inc.



For DTS patents, see <http://patents.dts.com>. Manufactured under license from DTS Licensing Limited. DTS, DTS:X, Virtual:X, and the DTS:X logo are registered trademarks or trademarks of DTS, Inc. in the United States and other countries. © 2021 DTS, Inc. ALL RIGHTS RESERVED.



Dolby, Dolby Vision, Dolby Audio, and the double-D symbol are trademarks of Dolby Laboratories Licensing Corporation. Manufactured under license from Dolby Laboratories. Confidential unpublished works. Copyright © 1992–2022 Dolby Laboratories. All rights reserved.

【STATEMENTS】

- The pictures and instructions in the user manual are only for reference, and may be different from appearance of actual products. Please make the object as the standard. (This statement is applicable throughout this user manual)
- Any change to service and quality upgrade, product design and specification will not be subject to any prior notice.
- User manual is only part of the application guidance instructions, and other applications can refer to the prompt in the application instructions.

9

Specifications

MODEL		43A6N	50A6N
Dimension (mm) (W×H×D)	Without stand	963 × 560 × 74	1119 × 650 × 80
	With stand	963 × 614 × 238	1119 × 685 × 247
Weight (kg)	Without stand	6.8	8.8
	With stand	6.9	9.0
Active screen diagonal size (cm)		108	126
Screen resolution		3840 × 2160	3840 × 2160
Power consumption		75W	110W
Audio power		8W + 8W	8W + 8W
MODEL		55A6N	65A6N
Dimension (mm) (W×H×D)	Without stand	1233 × 716 × 80	1453 × 838 × 76
	With stand	1233 × 751 × 298	1453 × 874 × 298
Weight (kg)	Without stand	10.9	15.0
	With stand	11.0	15.2
Active screen diagonal size (cm)		139	164
Screen resolution		3840 × 2160	3840 × 2160
Power consumption		110W	155W
Audio power		8W + 8W	10W + 10W
Standard		Q/0202RSR 669	
Power supply		100-240V ~ 50/60Hz	
Receiving system	RF	PAL(D/K、I、B/G)、NTSC(M)、DTMB	
	AV	PAL, NTSC	
Channel range		C01 ~ C57CATV Z01 ~ Z38	
Environmental conditions		Temperature: 5°C ~ 35°C Humidity: 20% ~ 80%RH Atmospheric pressure: 86kPa ~ 106kPa	

Antenna input	75Ω
DTV specification	Frequency: 474MHz-858MHz Transmission channel bandwidth: 8MHz Modulation: 64QAM, 16QAM, 4QAM Frame Header: Pn945 Symbol Interleaving: 720 Code Rate: 0.4, 0.6 Video decode Format: H.264, MPEG-2 Audio decode Format: MPEG-1, AC-3
Analogue tune	VHF-L: 48.25 ~ 168.25MHz VHF-H: 175.25 ~ 463.25MHz UHF: 471.25 ~ 863.25MHz

Below is the list of video format compatible:

Video format

Container	Video Codec	File Extension Name	Resolution and Frame Rate
MPEG program stream	MPEG1	.DAT, .VOB, .MPG, .MPEG	720 x 576 @ 30fps
	MPEG2		3840 x 2160 @ 30fps
	MPEG4		1920 x 1080 @ 60fps
	H.264		3840 x 2160 @ 60fps
MPEG transport stream	HEVC/H.265	.ts, .trp, .tp	3840 x 2160 @ 60fps
	MPEG4		1920 x 1080 @ 60fps
	H.264		3840 x 2160 @ 60fps
	VC1		1920 x 1080 @ 60fps
	MPEG1		720 x 576 @ 30fps
	MPEG2		3840 x 2160 @ 30fps
MP4	VP8	.mp4, .mov	1920 x 1080 @ 60fps
	AV1		3840 x 2160 @ 60fps
	HEVC/H.265		
	MPEG1		720 x 576 @ 30fps
	MPEG2		3840 x 2160 @ 30fps
	MPEG4		1920 x 1080 @ 60fps
	H.263		1408 x 1152 @ 60fps
	WMV3		1920 x 1080 @ 60fps
	VC1		
	H.264		
Motion JPEG	3840 x 2160 @ 60fps		
MKV	VP9	.mkv	3840 x 2160 @ 60fps
	HEVC/H.265		720 x 576 @ 30fps
	MPEG1		
	MPEG2		
	MPEG4		
	H.264		

Container	Video Codec	File Extension Name	Resolution and Frame Rate
MKV	WMV3	.mkv	1920 x 1080 @ 60fps
	VC1		
	Motion JPEG		
	VP8		
	AV1		
AVI	HEVC/H.265	.avi	3840 x 2160 @ 60fps
	MPEG1		720 x 576 @ 30fps
	MPEG2		3840 x 2160 @ 30fps
	MPEG4		1920 x 1080 @ 60fps
	H.263		1408 x 1152 @ 60fps
	H.264		3840 x 2160 @ 60fps
	WMV3		1920 x 1080 @ 60fps
	VC1		
	Motion JPEG		
	VP8		
	VP9		
FLV	HEVC/H.265	.flv	3840 x 2160 @ 60fps
	MPEG4		1920 x 1080 @ 60fps
	H.263		1408 x 1152 @ 60fps
	H.264		3840 x 2160 @ 60fps
WEBM	VP9	.webm	3840 x 2160 @ 60fps
	VP8		1920 x 1080 @ 60fps
	AV1		3840 x 2160 @ 60fps

Image format

Image	Photo	Resolution
JPEG	Base-line	16383 x 16383
	Progressive	1920 x 1080
PNG		8192 x 4320
BMP		
GIF		
WebP		

Audio format

Container	Audio Codec	File Extension Name
WAV	MPEG1/2 Layer1	.wav
	MPEG1/2 Layer2	
	MPEG1/2/2.5 Layer3	
	AAC-LC, HEAAC	
	DTS, DTS HD	
	LPCM	
MP3	MPEG1/2 Layer1	.mp3
	MPEG1/2 Layer2	
	MPEG1/2/2.5 Layer3	
AAC	AAC-LC, HEAAC	.aac
WMA	WMA7, WMA8, WMA9	.wma, .wmv
	WMA 10 Pro	
FLAC	FLAC	.flac
OGG	OPUS	.ogg

【 NOTE 】 We can not promise that this set would support all the formats listed above, as the programming tools are different.

HDMI Input	
RGB/60Hz	640×480、800×600、1024×768
YUV/50Hz	576i、576p、720p、1080i、1080p
YUV/60Hz	480i、480p、720p、1080i、1080p
YUV/24Hz 25Hz 30Hz	1080p、3840×2160
YUV/24Hz	4096×2160
YUV444/50Hz 60Hz	3840×2160