

## Quick Setup Guide

Help Hisense improve the environment by reducing paper waste. For detailed instructions and feature descriptions, access the full user manual online:

**[www.xclasstv.com/support/documentation/hisense](http://www.xclasstv.com/support/documentation/hisense)**

Before using the TV, please read this guide carefully and keep it for future reference.

# Copyright statement

© 2021 Hisense Company Ltd. and Comcast Corporation (“Comcast”). All Rights Reserved.

All material in this Quick Setup Guide is the property of Hisense Company Ltd. and Comcast and their subsidiaries, and is protected under the laws of the US and international copyright and/ or other intellectual property laws. Reproduction or transmission of the materials, in whole or in part, in any manner, electronic, print, or otherwise, without the prior written consent of the Hisense Company Ltd. and Comcast is a violation of the rights of Hisense Company Ltd. and Comcast under the aforementioned laws.

No part of this publication may be stored, reproduced, transmitted or distributed, in whole or in part, in any manner, electronic or otherwise, whether or not for a charge or for other or no consideration, without the prior written permission of Hisense Company Ltd. and Comcast. Requests for permission to store, reproduce, transmit or distribute materials may be made to one of the following addresses:

## USA:

**Hisense USA Corporation** 7310 McGinnis Ferry Road Suwanee, GA 30024

**Comcast Corporation**, One Comcast Center, 1701 JFK Blvd., Philadelphia, PA 19103

Hisense, and any and all other Hisense product names, logos, slogans or marks are registered trademarks of Hisense Company Ltd. and its subsidiaries. XClass TV, the “X” design, and all other Comcast product names, logos, slogans or marks are the trademarks of Comcast. All other trademarks are the property of their respective holders.

# Disclaimer

Disclaimer: Subscriptions or other payments may be required to access content through some applications. Some or all of the included or downloaded application services in this device may not function depending on the Internet connection, local limitations of included applications or other reasons outside of Hisense’s and/or Comcast’s control. HISENSE AND COMCAST EXPRESSLY DISCLAIM RESPONSIBILITY FOR ANY APPLICATION SERVICE FROM FUNCTIONING AT ANY TIME, FOR CONTENT IN ANY APPLICATION SERVICE, FOR DISRUPTIONS OF SERVICE, LOCAL OR REGIONAL LIMITATIONS, WARRANTIES OF TITLE, WARRANTY OF NON-INFRINGEMENT, AND FOR IMPLIED WARRANTIES OF MERCHANTABILITY OR FITNESS FOR A PARTICULAR PURPOSE. By purchasing and using this device, you accept such Disclaimer without any claim on Hisense and/or Comcast at any time.

***This Quick Setup Guide supports the following models:***

**43A6GX/50A6GX/43A6GX3/50A6GX3**

## **Table of Contents**

What's in the box .....	3
Getting started .....	4
Step 1. Attach stand or mount.....	4
Step 2. Connect devices to your TV .....	6
Step 3. Get your remote ready.....	9
Step 4. Power on the TV .....	11
Step 5. Set up your TV.....	11
Step 6. Enjoy your TV! .....	12
Troubleshooting .....	13
Product specifications.....	14
Certification and compliance .....	15

Congratulations on the purchase of your Hisense XClass TV! To learn more about all things Hisense, contact us using the support info below. To learn more about XClass TV's privacy practices, please use the below link to view our privacy policy.

The model and serial number of the TV is located on the back or side of the TV. We recommend that you record this information if you ever need service.

Country	Customer Care Center	Hisense Support Page	Device Registration	XClass TV Privacy Policy
U.S.A	<ul style="list-style-type: none"> <li>• <b>Phone:</b> 1-888-935-8880</li> <li>• <b>Hours of Operation:</b>  Monday - Friday: 9 AM to 9 PM EST  Saturday - Sunday: 9 AM to 6 PM EST</li> <li>• <b>Service Email:</b>  Service@hisense-usa.com</li> </ul>	<p><a href="http://www.hisense-usa.com/support/">http://www.hisense-usa.com/support/</a></p> 	<p><a href="http://www.hisense-usa.com/support/register">http://www.hisense-usa.com/support/register</a></p> 	<p><a href="http://www.xclasstv.com/privacy/policy">http://www.xclasstv.com/privacy/policy</a></p> 

**Disclaimer:** This Quick Setup Guide is intended as a general guideline to help you set up your TV. Images throughout this document are for illustrative purposes only and may differ from the actual product.

# What's in the box

Your Hisense XClass TV comes with the following items:

- TV
- 1 set of AAA (1.5Vcc) batteries
- Remote control
- Power cord
- 4 screws (M4x16 for 43" TVs)  
4 screws (M4x12 for 50" TVs)
- Quick Setup Guide (this document)
- 2 base stands
- Important safety information and warranty card

## IMPORTANT:

To prevent accidentally discarding items that came with your TV, be sure to **check ALL of the foam** in the box.

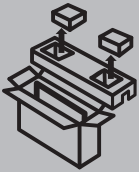

- Please check foam for accessories before discarding.
- Veuillez vérifier la mousse pour qu'il n'y ait pas d'accessoires avant de la jeter.
- Antes de desechar la espuma, asegúrese de retirar todos los accesorios.

You will also need the following items (which are not included) to set up your TV:

- Wireless router for Internet connectivity
- Phillips screwdriver to secure the TV stand
- HDMI and other types of cables to connect external devices to the TV
- Optional: Wall mount and screws to mount the TV on the wall

# Getting started

## Step 1. Attach stand or mount

Before using your TV, attach your TV stand or mount it on the wall.

### CAUTION:

- Disconnect the AC power cord before installing a stand or a wall mount bracket.
- The LED display on your TV is fragile. Make sure the TV screen is not scratched or damaged by hard objects or from pressure.
- After the installation is complete, make sure the TV is steady on a table or firmly attached to a wall mount before removing all protective film, if any.

## Attach the TV stand

To attach the TV stand legs to your TV:

1. Carefully place your TV face down on a clean, soft and flat surface.
2. Insert the TV base stands into the bottom slots on your TV.
3. Use the screws provided to secure each leg tightly.

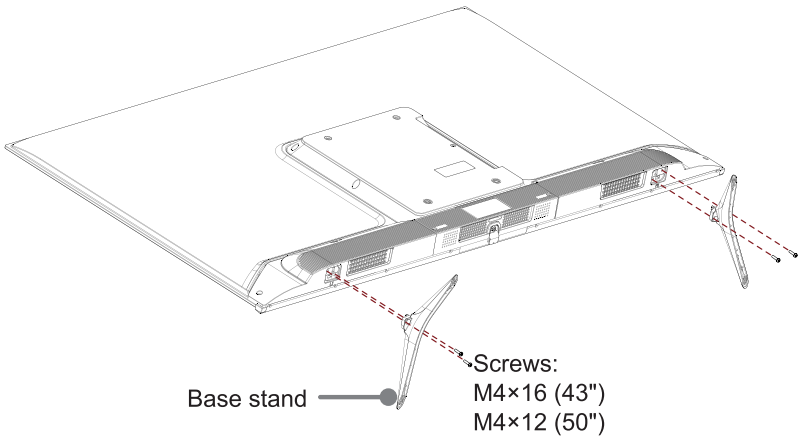

## Attach the wall mount bracket (not included)

Before you begin the third-party manufacturer instructions, be sure to do the following things:

1. Place the TV face down on a clean, safe and cushioned surface.
2. Remove the TV stand if you have already attached it.
3. Place spacers (not included) in the corresponding bracket holes.

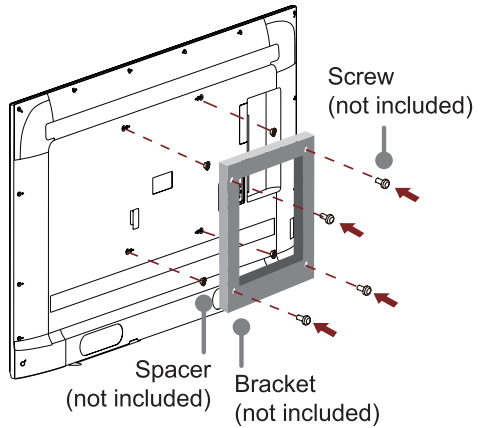

### CAUTION:

- Follow instructions provided with the wall mount bracket. If it is not correctly mounted, the TV may fall and cause property damage or personal injury.
- When you attach the mount, be sure to use spacers (provided by the third-party manufacturer) between the TV and the bracket.
- To prevent internal damage to the TV and to ensure it is mounted securely, be sure to use fixing screws (not included) that are 8.0 - 10.0 mm in length when measured from the attaching surface of the rear cover.
- Make sure the tilt angle between the TV screen and the vertical surface is no more than 15 degrees.

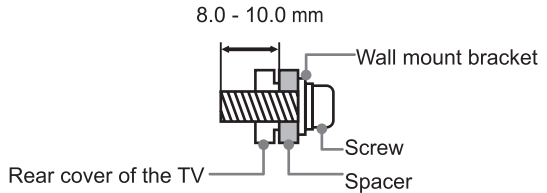
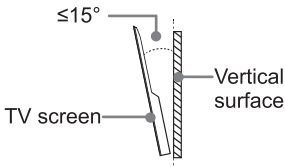

Wall mount hole pattern (mm)	200 × 300
Wall mount screw size	M6

### NOTE:







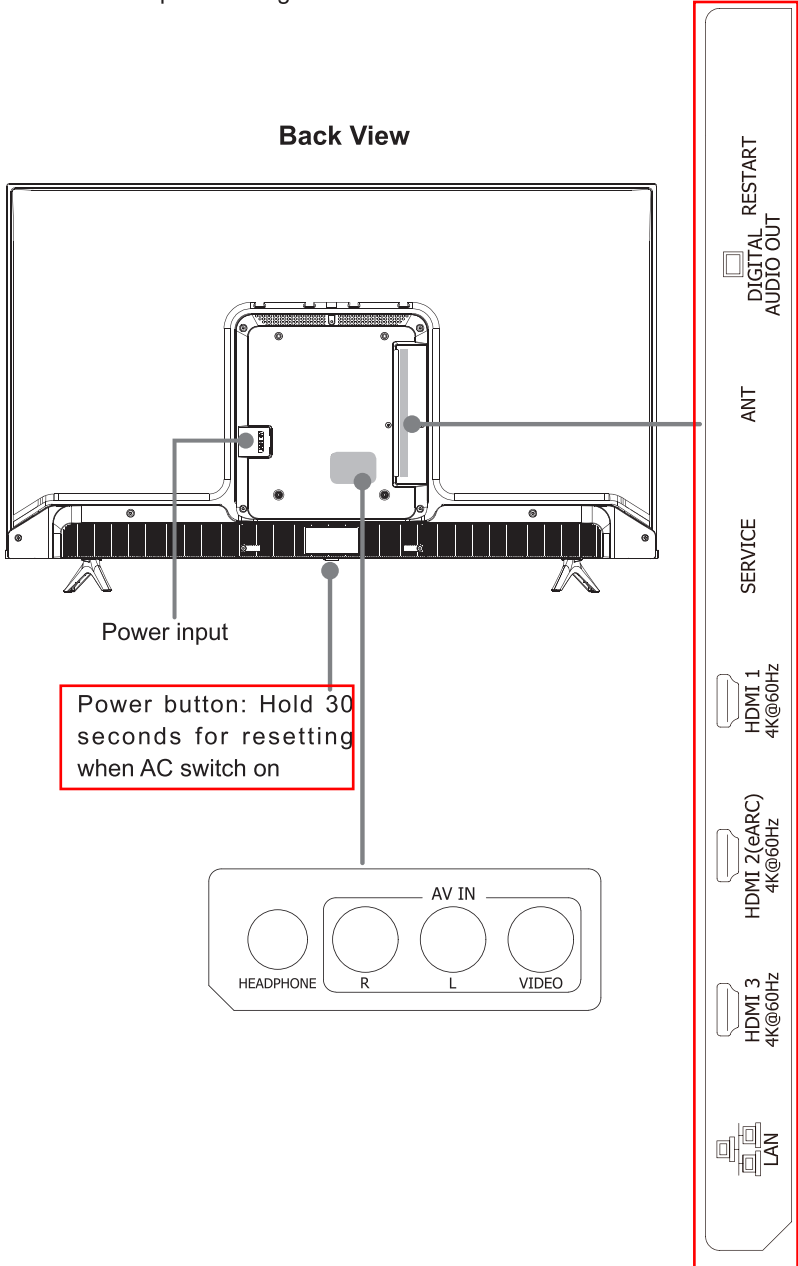

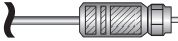
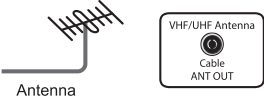

- If you have additional questions, please contact the wall mount manufacturer or the retailer from which you purchased the TV.
- The diameter and length of the screws differ depending on the wall mount bracket model.

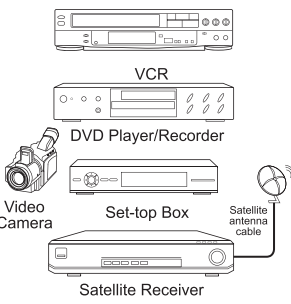

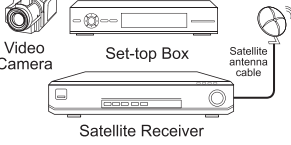

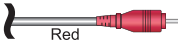
## Step 2. Connect devices to your TV

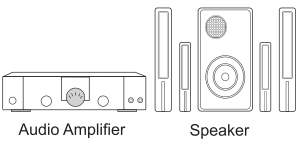
Check to ensure that you have connected right cables for right ports securely. Loose connections can affect picture image and color.





TV label	Port	Cable	External Equipment	Brief Description
ANT			 <p>Antenna</p> <p>VHF/UHF Antenna Cable ANT OUT</p>	Connect an outdoor VHF/ UHF antenna.
HDMI			 <p>VCR</p> <p>DVD Player/Recorder</p> <p>Video Camera</p> <p>Set-top Box</p> <p>Satellite Receiver</p>	Connect a High Definition Multimedia Interface (HDMI) cable from an external device.
AV IN	VIDEO	 Yellow	 <p>Video Camera</p> <p>Set-top Box</p> <p>Satellite Receiver</p> <p>Satellite antenna cable</p>	Connect a composite video cable and left-right audio cables from an external AV device.
	L	 White		
	R	 Red		
DIGITAL AUDIO OUT			 <p>Audio Amplifier</p> <p>Speaker</p>	Connect an optical cable from an external digital audio system.
HEADPHONE				Connect headphones to hear audio from the TV. Headphones with microphones are not supported.

TV label	Port	Cable	External Equipment	Brief Description
LAN				<p>Connect an Ethernet cable to access a network or the Internet. The TV is also WiFi-compatible.</p>
SERVICE		<p>This port can only be used by factory for testing purposes. This port may not be available in some models.</p>		



### Step 3. Get your remote ready

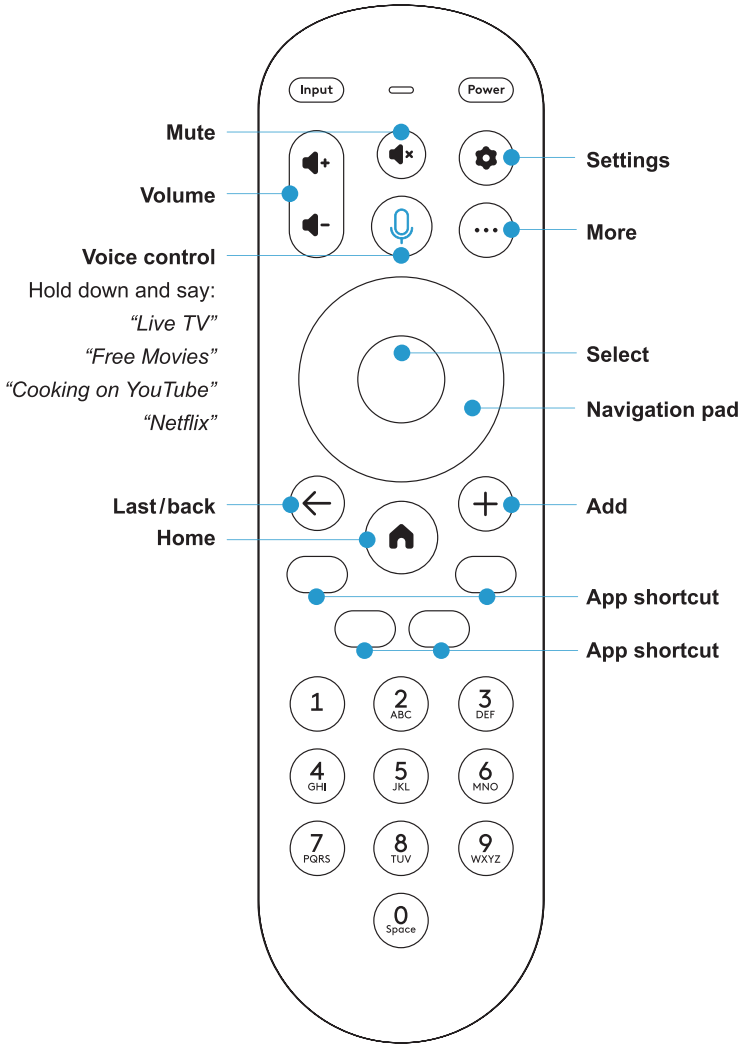

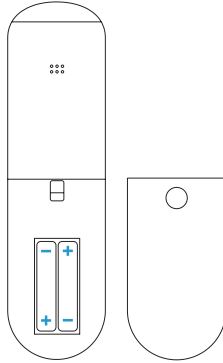

### Set up your remote in just a few easy steps

1. Push the battery cover down and slide it off the remote
2. Insert the included batteries
3. Replace the battery cover

### Pairing your remote to a new TV

If you set up your remote within 15 minutes of plugging in your TV for the first time, your remote will automatically pair. Your remote should pair automatically, but if you experience any issues, please follow instructions under "Pairing your remote to an existing TV".

### Pairing your remote to an existing TV

1. Press the  button
2. Follow the on-screen instructions
3. If you're having trouble, try pressing and holding the 1 and 3 buttons simultaneously for 3 seconds

### Pairing your remote to a sound system

1. Press the  button
2. Select Remote > Pair your remote and sound system
3. Follow the on-screen instructions

### CAUTION

- Properly dispose of old batteries in a designated area. Do not throw old batteries into a fire
- Remove old batteries immediately to prevent them from leaking
- Remove the batteries from your remote if you don't intend to use it for a while
- If the batteries leak, be sure to clean the battery compartment. Wash your skin immediately if you come into contact with battery chemicals
- Do not mix old and new batteries
- Do not mix alkaline, standard (carbon-zinc), or rechargeable (for example NiCd or NiMH) batteries
- If your remote gets warm or hot during use, stop using it and contact customer support immediately at [www.hisense-usa.com/support](http://www.hisense-usa.com/support)

## Step 4. Power on the TV

Connect your power cord to the TV and plug it into a power outlet. Your TV will display a launch screen showing the Hisense XClass TV logo.

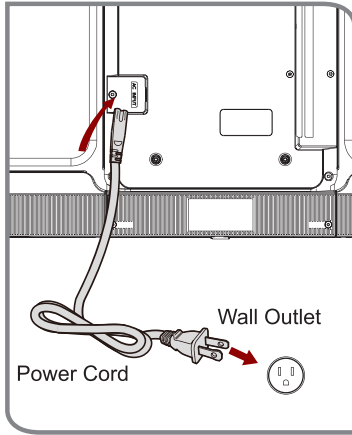

## Step 5. Set up your TV

Turn on your TV and follow the on-screen instructions to connect it to the Internet and set your preferences.

## **Step 6. Enjoy your TV!**

Your Hisense XClass TV gives you access to instant entertainment, all in one place. Connect to your favorite apps to start streaming today. Plus, a personalized launchpad gives you a tailored experience.

Press the Home button on your remote to get started.

### **Voice Guidance and Audio Description (AD)**

Voice Guidance and Audio Description (AD) can help you to navigate on-screen menus and hear audio descriptions of compatible programs. Voice Guidance reads written text aloud to help convey information. Audio Description (AD) narrates compatible programs by describing main visual elements.

Follow the steps below to turn on these features:

1. Press the Settings button on your remote.
2. Select Accessibility > Voice Guidance or Accessibility > Audio Description (AD).

# Troubleshooting

If you are having trouble with your TV, first try turning it off and on again. If this does not fix the problem, check the tips in the following table. If your problem is not listed, then contact us.

Issues	Possible solutions
No sound or picture	<ul style="list-style-type: none"> <li>• Check if the power cord is plugged into an active outlet.</li> <li>• Press the Power button on the remote control to make sure the TV is not asleep.</li> <li>• Check to see if the LED light is on. If it is, then the TV is receiving power.</li> </ul>
I have connected an external source to my TV but there is not picture or sound.	<ul style="list-style-type: none"> <li>• Make sure the external source is plugged into the correct output and input connections.</li> <li>• Make sure you have turned your TV to the correct input. For example, if you are connecting something using an HDMI cord, be sure your TV is turned to the HDMI source.</li> </ul>
When I turn on my TV, there is a delay for a few seconds before the picture appears.	<ul style="list-style-type: none"> <li>• This is normal. The TV is initializing and searching for previous setting information.</li> </ul>
The picture is normal but there is no sound.	<ul style="list-style-type: none"> <li>• Check the volume settings.</li> <li>• Check if your TV is muted.</li> </ul>
The sound is on but there is no picture, or the picture is in black and white.	<ul style="list-style-type: none"> <li>• If the picture is black and white, unplug the TV from the power outlet, wait 60 seconds, then plug it back in.</li> <li>• Check your TV color settings under Settings &gt; Picture and sound</li> <li>• Try different TV channels.</li> </ul>
The sound and/or picture is distorted or appears wavy.	<ul style="list-style-type: none"> <li>• An electric appliance may be affecting the TV. Turn off any appliances that are nearby and move them farther away from the TV.</li> <li>• Try plugging the TV into a different power outlet.</li> </ul>
The sound and picture is blurry or cuts out.	<ul style="list-style-type: none"> <li>• If you are using an external antenna, check its direction, position and connection.</li> <li>• Reset or fine tune the channel.</li> </ul>
A horizontal or vertical stripe appears on the picture and/or the picture is shaking.	<ul style="list-style-type: none"> <li>• Check if there is an appliance or electric tool nearby that is causing interference. If there is, remove it.</li> </ul>
The TV makes a "clicking" type of sound.	<ul style="list-style-type: none"> <li>• This is normal and happens when the TV's temperature changes. The change causes the TV cabinet to expand or contract, which then causes the noise.</li> </ul>
The remote control does not work.	<ul style="list-style-type: none"> <li>• Confirm that TV still has power and is operational.</li> <li>• Change the batteries in the remote control.</li> <li>• Check that the batteries are correctly installed.</li> </ul>

# Product Specifications

Model Name		43A6GX/43A6GX3	50A6GX/50A6GX3
Dimension (W × H × D)	Without Stand	37.9 × 22.0 × 2.9 in (963 × 560 × 74 mm)	44.0 × 25.4 × 2.9 in (1117 × 646 × 74 mm)
	With Stand	37.9 × 24.2 × 7.7 in (963 × 614 × 196 mm)	44.0 × 27.9 × 8.9 in (1117 × 709 × 225 mm)
Weight	Without Stand	15.0 lbs (6.8 kg)	21.6 lbs (9.8 kg)
	With Stand	15.2 lbs (6.9 kg)	22.0 lbs (10.0 kg)
TV Stand Width (W × D)		32.9 × 7.7 in (835 × 196 mm)	38.0 × 8.9 in (964 × 225 mm)
Class		43" (109.2 cm)	50" (127.0 cm)
Active Screen Size (Diagonal)		42.5 in (107.9 cm)	49.5 in (125.7 cm)
Screen Resolution		3840 × 2160	
Audio Power		7 W + 7 W	8 W + 8 W
Power consumption		100 W	120 W
Power Supply		120 V ~ 60 Hz	
Connectivity		Built-in Wireless feature (2x2 dual band)	
Ports		3 HDMI ports, 1 LAN port for Ethernet, 1 Digital Audio Output, 1 RF Input, 1 Headphone Audio Output, 1 RCA Composite Video Input , 1 left/right Audio Input for Composite	
Receiving Channels		VHF: 2 - 13, UHF: 14 - 69 Digital Terrestrial Broadcast (8VSB): 2 - 69	
Tuner Type		Frequency synthesized	
Receiving System		ATSC	
Operating Temperature		41°F - 95°F(5°C - 35°C)	
Operating Humidity		20% to 80% non-condensing	
Storage Temperature		5°F to 113°F(-15°C to 45°C)	
Storage Humidity		10% to 70%, non-condensing	

**Disclaimer:** All products, product specifications, and data are subject to change without notice to improve reliability, function, design or otherwise.



# Certification and Compliance

## FCC Notice

This device has been tested and found to comply with the limits for a Class B digital device pursuant to Part 15 of the FCC Rules. These limits are designed to provide reasonable protection against harmful interference in a residential installation. This device generates, uses, and can radiate radio frequency energy and, if not installed and used in accordance with the instructions, may cause harmful interference to radio communications.

However, there is no guarantee that interference will not occur in a particular installation. If this equipment does cause harmful interference to the reception of a radio or another television, which can be determined by turning this television off and on, the user is encouraged to try to correct the interference by one or more of the following measures:

- If you are using an antenna to receive over-the-air television signals, reorient or relocate the receiving antenna, increase the separation between the television and receiver, and/or connect the television into an outlet on a circuit different from that to which the receiver is connected.
- Tighten all connections between the television and other devices.
- Consult the dealer or an experienced radio/TV technician for help.

**NOTE:** The manufacturer is not responsible for any radio or TV interference caused by unauthorized modifications to this equipment. Such modifications could void the user's authority to operate the equipment.

The WiFi Module complies with FCC radiation exposure limits set forth for an uncontrolled environment. This device should be installed and operated with a minimum distance of 20 centimeters between the radiator and your body.

## Declaration of Conformity

Trade Name: Hisense

Model: 43A6GX/50A6GX/43A6GX3/50A6GX3

Responsible Party: Hisense USA Corporation

Address: 7310 McGinnis Ferry Road, Suwanee, GA 30024

Telephone Number: 678-318-9060

This device complies with Part 15 of the FCC Rules. Operation is subject to the following two conditions: (1) this device may not cause harmful interference, and (2) this device must accept any interference received, including interference that may cause undesired operation.



Dolby, Dolby Vision, Dolby Audio, and the double-D symbol are trademarks of Dolby Laboratories Licensing Corporation. Manufactured under license from Dolby Laboratories. Confidential unpublished works. Copyright © 1992–2021 Dolby Laboratories. All rights reserved.



The terms HDMI and HDMI High-Definition Multimedia Interface, and the HDMI Logo are trademarks or registered trademarks of HDMI Licensing Administrator, Inc. in the United States and other countries.



### Environmental Protection

This mark indicates that this product should not be disposed together with other domestic garbage, to avoid damage to the environment or human health due to the disposal of uncontrolled waste. Recycle it responsibly for promoting the sustainable reuse of material resources. To return your used device, please use the return systems available in your location or contact the vendor where you purchased your product they could take this product for recycling and protection of the environment. Consumers can find additional information about recycling and reuse programs available to them in certain states, including New York, at the following link: [www.mrmrecycling.com](http://www.mrmrecycling.com).

©2021. All rights reserved. Hisense and the Hisense logo are registered trademarks of Hisense. Other brand and product names are registered trademarks of their respective owners.